

AUXILIARY POWER SUPPLY

Series FA-5A

AE/FL-5A

AE/SA-FA

AE/94-FA

INSTALLATION AND OPERATING MANUAL

VERSION 1.1
NOV/2008

CONTENT

	PAGE
1 INTRODUCTION.....	3
1.1 PURPOSE OF THE MANUAL.....	3
1.2 OBSERVATIONS.....	3
1.3 WARNINGS AND PRECAUTIONS.....	3
1.4 APPROVALS.....	3
1.5 CHECKING THE POWER SUPPLY UNIT.....	4
2 INSTALLATION.....	5
2.1 DIMENSIONS.....	5
2.2 LOCATION OF THE POWER SUPPLY UNIT.....	6
2.3 ANCHORING THE BOX.....	6
3 CHARACTERISTICS.....	9
4 CONECTION.....	11
4.1 MAINS SUPPLY.....	11
4.2 EXTERNAL CONNECTIONS.....	12
4.2.1 Mains voltage input and output.....	12
4.2.2 Fault relay.....	13
4.2.3 Output 1.....	13
4.2.4 Output 2.....	13
4.2.5 Voltage input.....	13
4.2.6 Batteries.....	14
4.3 POWER SUPPLY UNIT AE/SA-FA – CONNECTION TO ALGORITHMIC LOOP.....	15
4.3.1 Coding.....	16
4.4 POWER SUPPLY AE/94-FA CONNECTION TO 3-WIRE ALGORITHMIC LOOP.....	17
4.4.1 Used auxiliary supply for operations.....	17
4.4.2 Used as supply for 1 algorithmic loop.....	18
4.4.3 Used as supply for 2 algorithmic loops.....	19
4.4.4 Coding.....	20
4.4.5 Operating mode of the 3-wire algorithmic loop output.....	20
5 OPERATION.....	21
5.1 SERVICE.....	21
5.2 GENERAL FAILURE.....	21
5.3 MAINS FAILURE.....	22
5.4 FAILURE OF BATTERIES.....	22
5.5 CHARGER FAULT.....	23
5.6 OUTPUT 1 FAULT.....	23
5.7 OUTPUT 2 FAULT.....	23
5.8 MAXIMUM CURRENT LIMIT.....	24
5.9 GROUND FAULT.....	25
5.10 SYSTEM FAULT.....	25
5.11 TEST.....	25
5.11.1 Test of indicator lamps.....	26
5.11.2 Battery charge test.....	26
6 TECHNICAL CHARACTERISTICS.....	27

1 INTRODUCTION.

1.1 PURPOSE OF THE MANUAL.

The purpose of this manual is to provide the user with a full description concerning the recommended procedures and technical details in order to carry out the installation and commissioning of the auxiliary power supplies of the FA series.

The procedures described in this manual include warnings and instructions to alert the user to adopt safe and methodical working practices during the installation and commissioning.

1.2 OBSERVATIONS.

- The following manual is only applicable for the wiring and commissioning of the auxiliary power supplies of the FA-5A series.
 - AE/ SA-FA: Auxiliary 5A power supply for the algorithmic system.
 - AE/94-FA: Auxiliary 5A power supply for the analogical system.
 - AE/ FL-5A: Auxiliary 5A power supply.

For other power supply versions, consult the corresponding manual

- The manufacturer reserves the right to change, amend or correct the information without prior notice.

1.3 WARNINGS AND PRECAUTIONS.

 The installer of the auxiliary power supplies and of the units that form the Fire Detection System has to be an authorized installer who has received training in the handling of the Fire Panel, as well as in the current regulations.

The user should read this manual and fully understand the content thereof before beginning any task related with the auxiliary power supply. If any doubt exists in the matters described in the manual, the supplier should be consulted before beginning the installation and commissioning.

1.4 APPROVALS.

The auxiliary power supplies of the FA-5A series have been designed according to:

- Standard EN54-4, both the mandatory functions and some optional ones with requirements.
- Electromagnetic compatibility with the Community Directive EEC/89/336 and amendments EEC/92/31 and EEC/93/68.
- Compatibility with the Community Low Voltage Directive EEC/73/23 and amendment EEC/93/68.

1.5 CHECKING THE POWER SUPPLY UNIT.

Before beginning its installation, it is important to carry out a visual inspection to ensure that the equipment supplied has not suffered any damage. If any irregularity is observed, **DO NOT PROCEED** with its installation and contact your supplier.

2 INSTALLATION.

2.1 DIMENSIONS.

The Power Supply Unit is housed in a metallic cabinet 273 mm high X 320 mm wide X 123 mm deep.

It is recommended to leave a space free of at least 100mm around the whole box to allow proper ventilation of the unit.

The measurements are shown in the following diagram:

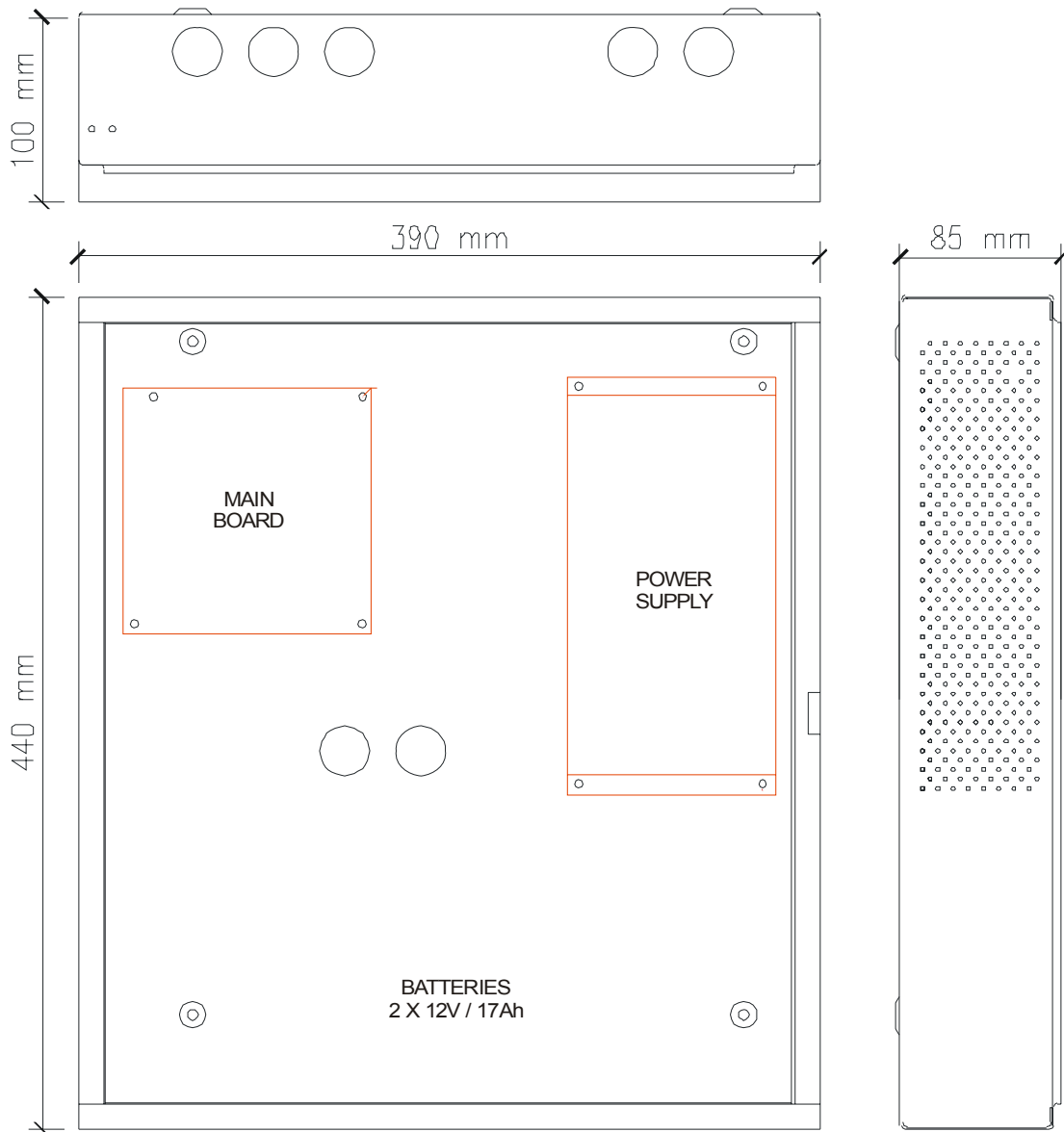

2.2 LOCATION OF THE POWER SUPPLY UNIT.

The Power Supply Unit should be installed in an appropriate place, in an area that is policed and protected and meets a series of requirements:

- The ambient operating temperature remains between +5° C and +35° C.
- The relative humidity is between 5% and 90%.
- It will be mounted on a wall so as to allow easy access to its interior, and to view the indicator pilots
- The power supply should not be located in an area exposed to high levels of humidity.
- The power supply should not be located in areas exposed to vibration or impact.
- The power supply should not be located in areas where access is blocked to the internal equipment and the wiring connections.

For the satisfactory operation of the unit, it is necessary to respect the indicated distances to achieve proper ventilation and avoid overheating of the unit.

2.3 ANCHORING THE BOX.

i The Power Supply Unit can weigh more than 20kg with the batteries installed. When the box is secured to the wall, use appropriate fastening elements and strengthen the wall if necessary.

Prepare the necessary holes for the cables to enter the fire panel:

- If the entrance is foreseen from above or below, open the holes by means of a sharp blow on the stamped hole, taking care not to hit outside the area marked. Only make the perforations that are necessary.
- Secure the Fire Panel box to the wall in an appropriate place, using the three 6mm diameter holes provided.

The following figure shows the box anchoring measurements:

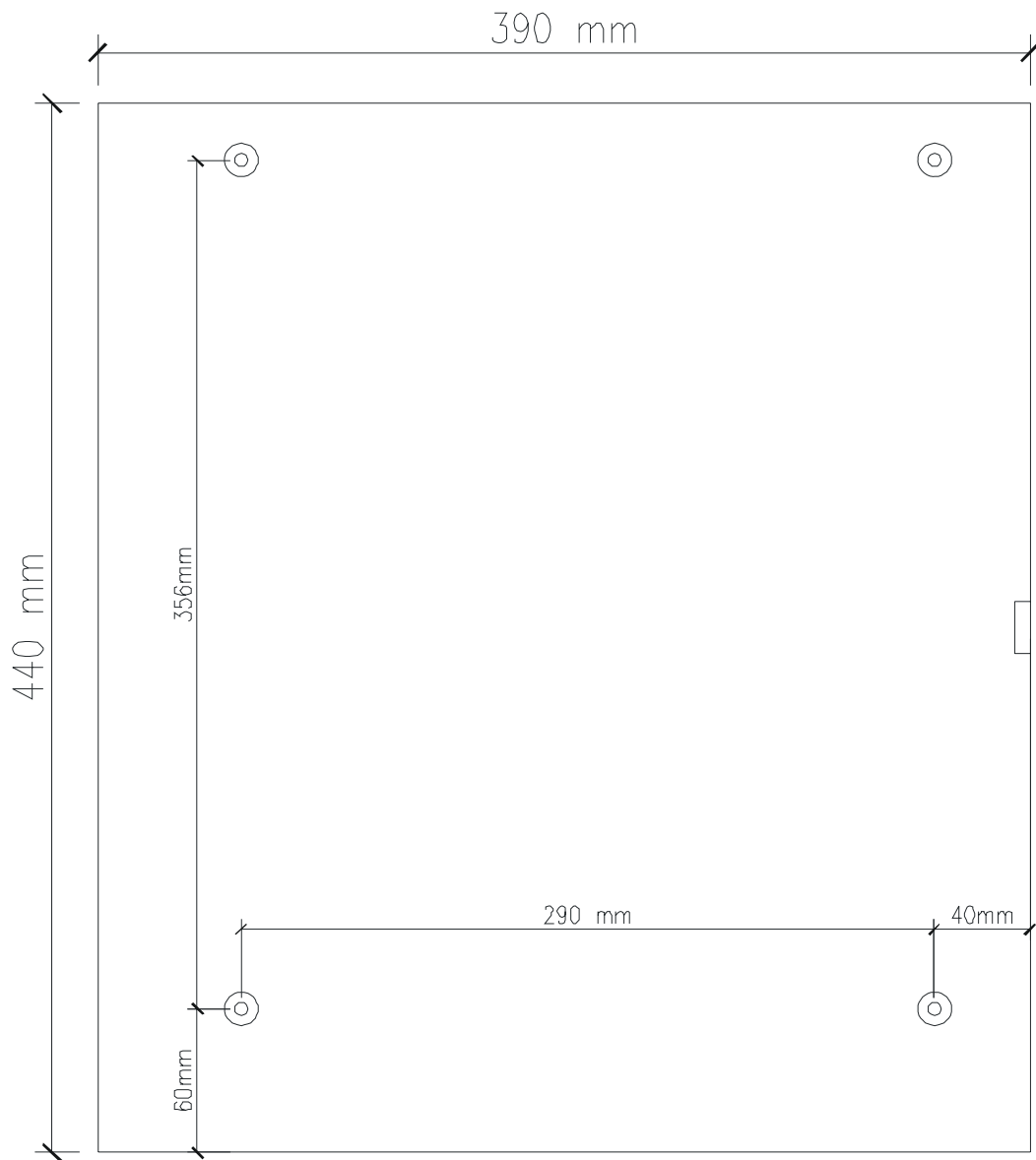

3 CHARACTERISTICS

The auxiliary power supplies of the FA-5A series are switched power sources with a microprocessor-based control circuit, designed according to the European Standard EN 54-4. They comprise the following:

- Switched 150W power supply.
- Mains voltage monitor.
- Earth fault detection.
- Output voltage and battery monitoring.
- Battery charging monitor.
- 2 independent voltage outputs, with protection fuse.
- Possibility to associate an output to the operation of the algorithmic 3 wire loop.
- Total output current monitor.
- Indicator pilot lamps.
- Indicator and battery charge test key.
- General fault state relay.
- Possibility of integration in Fire Panels of the 2- and 3-wire Algorithmic System, through an interface for the corresponding system.
 - AE/SA-FA: Auxiliary 5A power supply for the algorithmic system.
 - AE/94-FA: Auxiliary 5A power supply for the analogical system.
 - AE/FL-5A: Auxiliary 5A power supply.

4 CONECTION.

4.1 MAINS SUPPLY.

i Before making any connection, make sure that the cables are not live by cutting off the voltage at the corresponding switchboard.

The Auxiliary Power Supply is fed from a voltage range between 110 and 250Vac, 50/60Hz.

The conduits and the mains wiring should be kept separate from the rest of the fire panel cabling.

For the power cable entry point use the hole at the right end.

Feed the cable through the appropriate gland for the cable type employed.

The connection is made on the three-post connector as shown in the following figure:

- The phase cable (brown) should be connected to terminal L.
- The neutral cable (blue or black) should be connected to terminal N.
- The earth cable (yellow - green) should be connected to terminal T.

The connector has a 4A fuse.

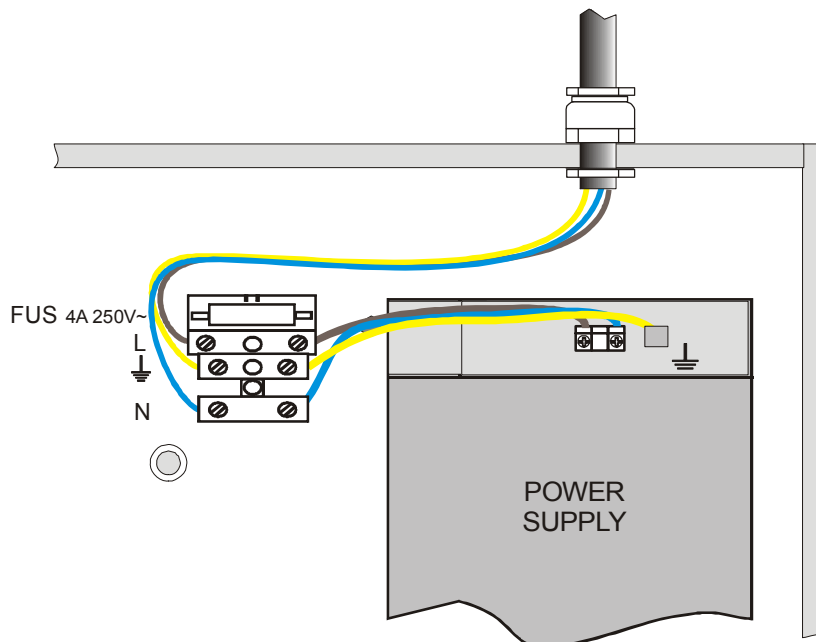

The supply for the fire monitoring units shall have a differential breaker for independent protection with a protection fuse of 230Vac / 5A or above. The section of the power supply wires will not be less than 0.75 mm².

4.2 EXTERNAL CONNECTIONS

The connection of the Auxiliary Power Supply is carried out on the connection posts located in the base board.

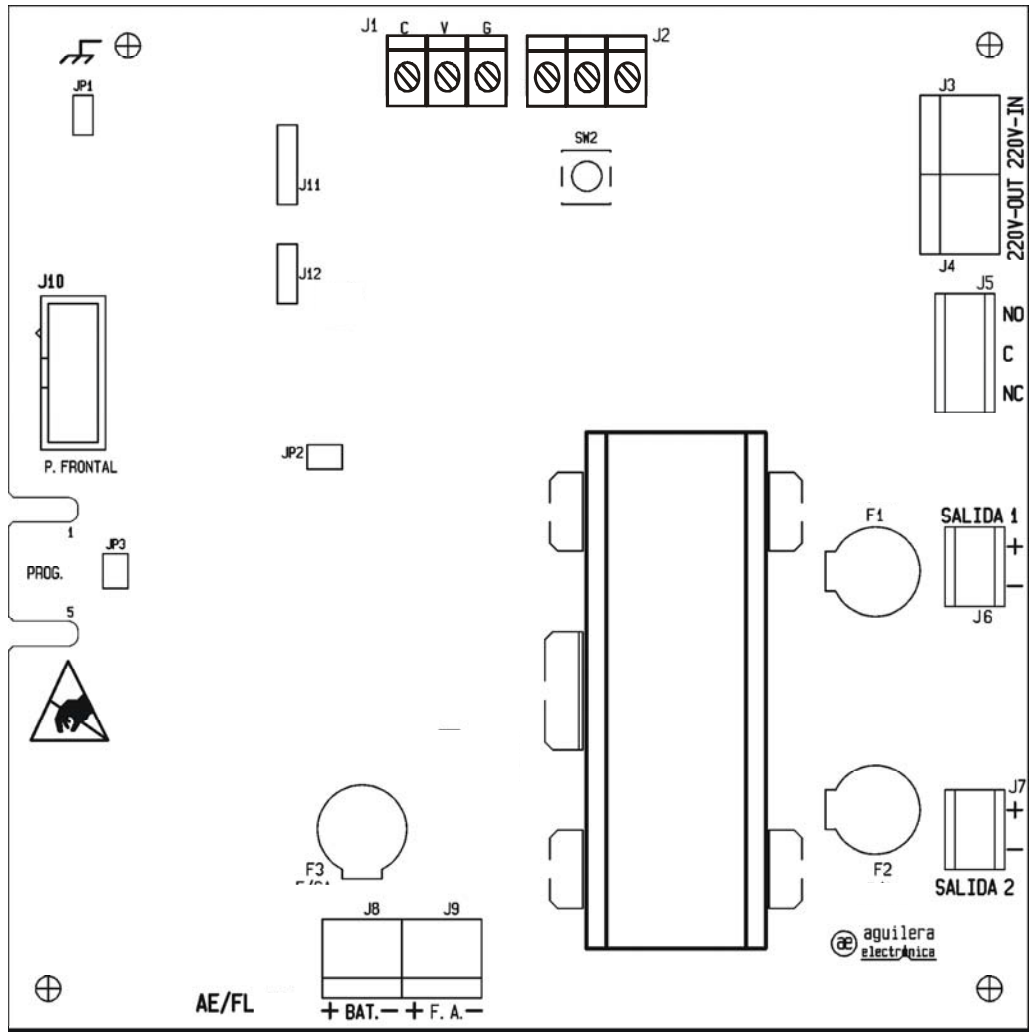

Any incorrect connection made to the lines of the auxiliary power supply can cause harm to the Control Circuit.

The allocation of the posts and connectors is as follows:

4.2.1 MAINS VOLTAGE INPUT AND OUTPUT.

The J3 connectors, mains voltage input (100 ... 240V AC 50/60 Hz) to the control circuit from the mains voltage connection plug, and output J4 for feeding the switched power supply.

This connection is installed in the factory and should not be manipulated, except for replacement of the base board.

4.2.2 FAULT RELAY.

Fault state repeating relay. It changes state at the same time as the General Fault indicator pilot is activated.

The pin-out of the J5 connector is the following:

NO	Contact normally open.
C	Common contact.
NC	Contact normally closed.

4.2.3 OUTPUT 1.

Supply voltage output, with a maximum current of 3 A, monitored and protected by fuse.

The pin-out of the J6 connector is the following:

- + Output of +24Vdc / 3A maximum.
- Common negative output.

This output can be associated with the 3-wire algorithmic loop output J2, controlled by means of the algorithmic interface. Consult section 4.4.5 for fuller information.

4.2.4 OUTPUT 2

Supply voltage output, with a maximum current of 3 A, monitored and protected by fuse.

The pin-out of the J7 connector is the following:

- + Output of +24Vdc / 3A maximum.
- Common negative output.

The total output current of the two outputs should not EXCEED 4,5 Amps. If this limit is surpassed, it is indicated by means of indicator pilots, and disconnection of the outputs takes place to avoid harming the switched power supply by overload. (The rest of the current up to 5A is reserved for charging the batteries).

4.2.5 VOLTAGE INPUT.

The output voltage of the switched supply is connected to the control circuit of the base board through the connector J9.

This connection is installed in the factory and should not be manipulated, except for replacement of the base board.

4.2.6 BATTERIES.

Two 12V/17Ah batteries are to be used, connected in series to deliver 24V, as indicated in the following diagram.

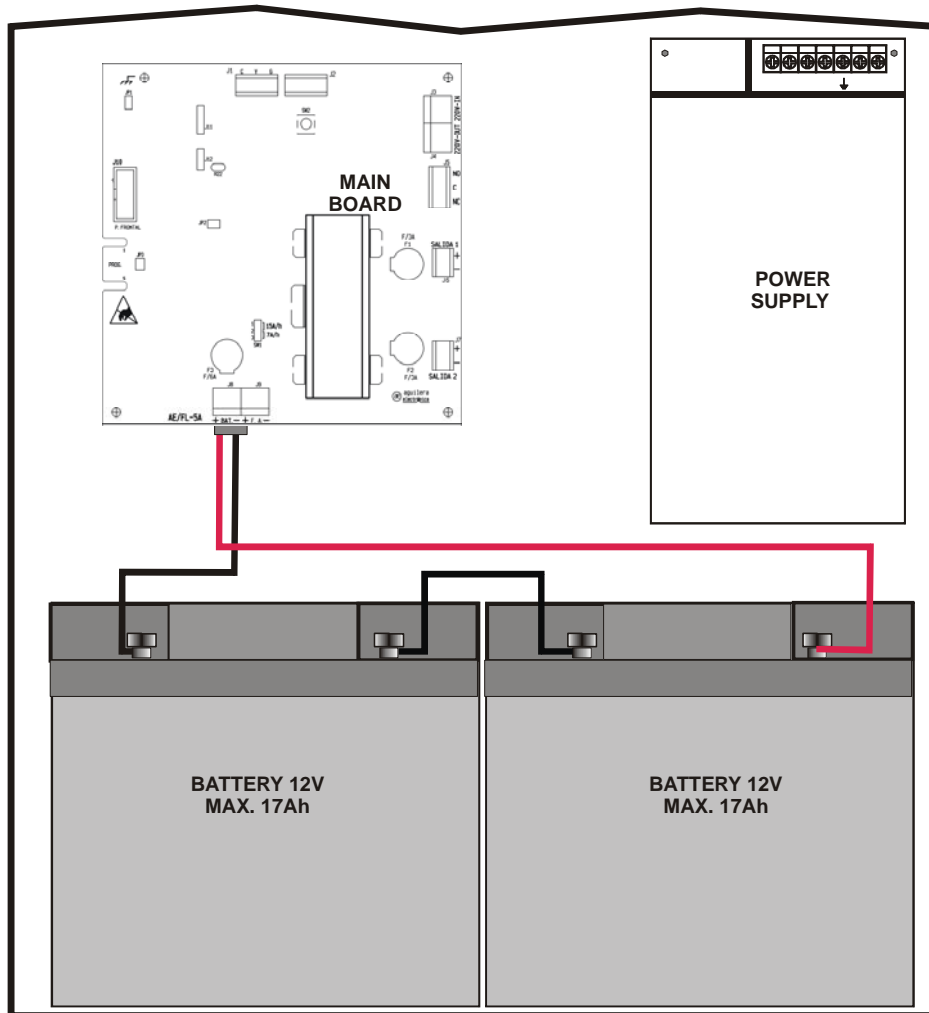

4.3 POWER SUPPLY UNIT AE/SA-FA – CONNECTION TO ALGORITHMIC LOOP

When the Power Supply Unit is integrated in an installation monitored by a 2-Wire Algorithmic System Fire Panel of Aguilera Electrónica, the connection to the algorithmic loop is made through the J1 plug located on the upper part of the base board.

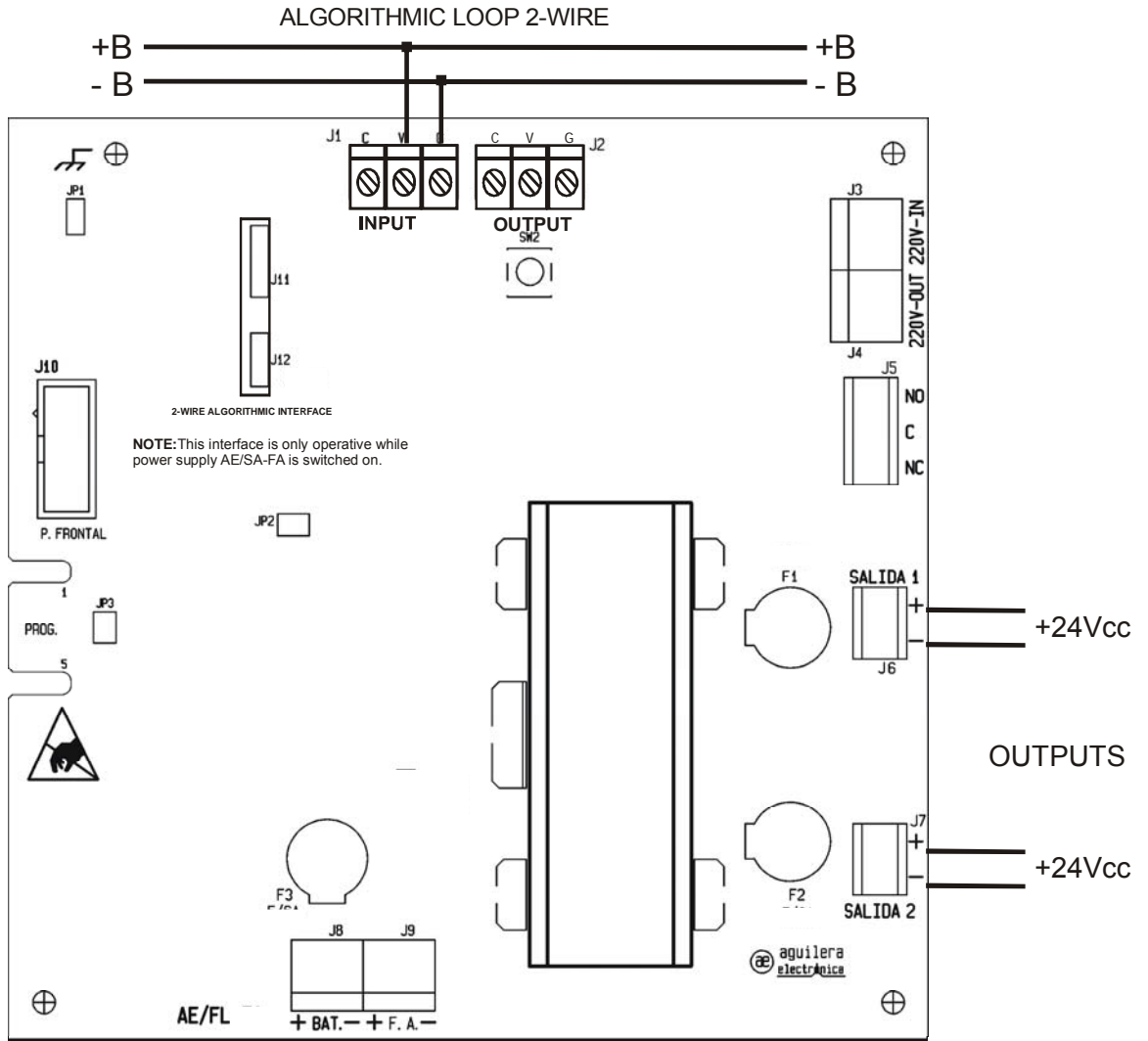

The allocation of contacts is the following:

- V Loop positive
- G Common negative

For the correct operation, it is necessary that the 2-wire algorithmic module interface is placed on the J11 and J12 connectors.

The power outputs are each limited to 3A by the board fuse. When it is necessary to increase this power level, the fuse has to be changed to the value corresponding to the desired level. It must always be remembered that the maximum output current of the unit is limited to 4.5A..

4.3.1 CODING

The Power Supply Unit AE/SA-FA must be coded with a number that corresponds to its personalization. The recording of the panel numbering can be carried out from:

1. Manual address programmer AE/SA-PRG. To achieve this, connect the output of the module programmer to the input socket of the algorithmic loop J1. To carry out the programming process, consult the programmer manual for the pertinent coding.
2. Algorithmic Panel. See the operating manual of the algorithmic fire panel for its coding and program a number between **1** and **125** as corresponds for its personalization. For the Algorithmic System, the panel occupies a single position in the algorithmic loop.

The identification number of the unit, as well as the operational identifier, are stored in the interface EEPROM memory. Before connecting the panel to the algorithmic loop, **verify it is correctly coded.**

4.4 POWER SUPPLY AE/94-FA CONNECTION TO 3-WIRE ALGORITHMIC LOOP

When the Power Supply Unit is integrated in an installation monitored by a 3-Wire Algorithmic System Fire Panel of Aguilera Electrónica, the connection to the algorithmic loop is made through the J1 and J2 plugs located on the upper part of the base board.

Three (3) different types connection can be carried out, depending on the use that it is desired to give the Auxiliary Power Supply Unit.

4.4.1 USED AUXILIARY SUPPLY FOR OPERATIONS.

The integration in the 3-wire algorithmic loop is only carried out through plug J1.

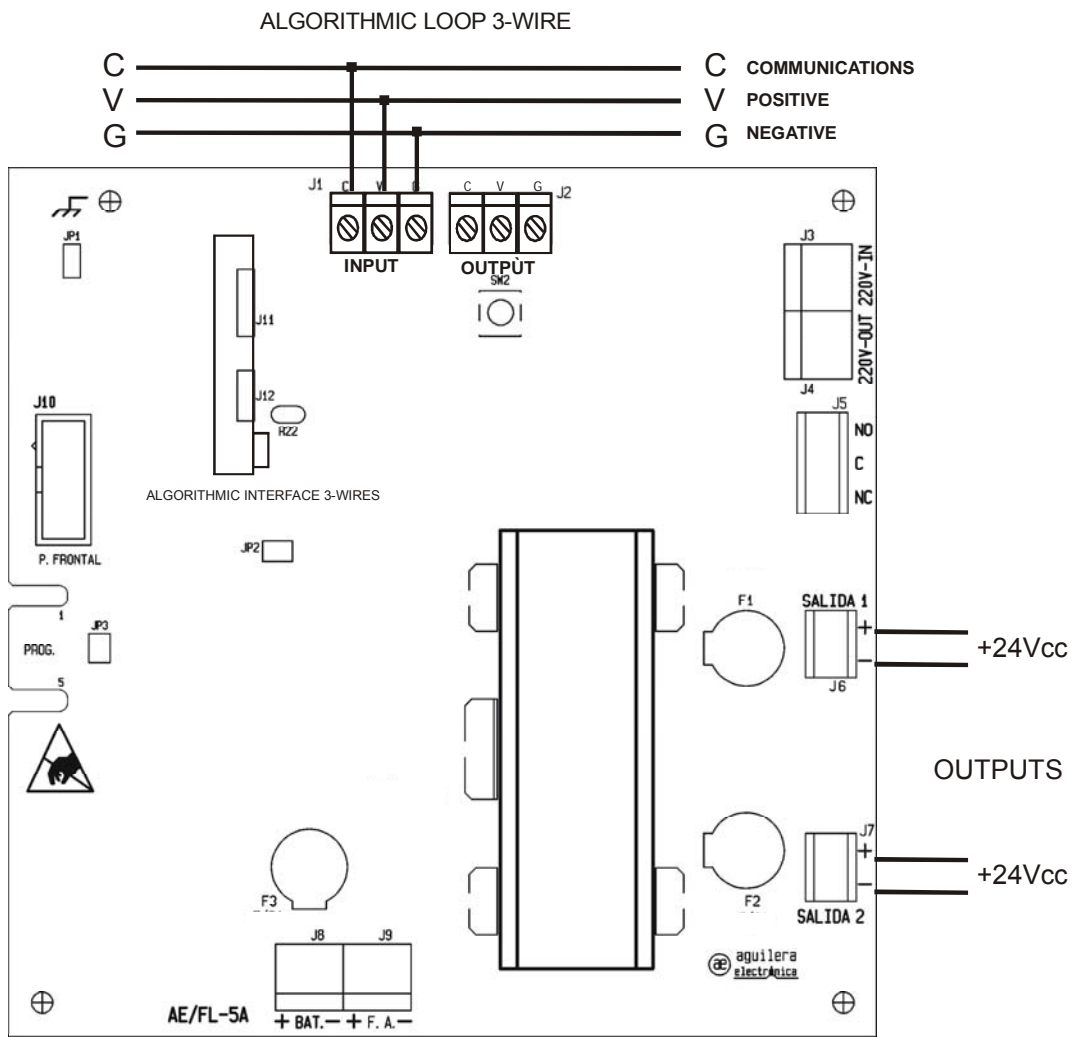

For the correct operation, it is necessary that the 3-wire algorithmic module interface be mounted on the J11 and J12 connectors.

The power outputs are each limited to 3A by the board fuse. When it is necessary to increase this power level, the fuse has to be changed to the value corresponding to the desired level. It must always be remembered that the maximum output current of the unit is limited to 4.5A.

4.4.2 USED AS SUPPLY FOR 1 ALGORITHMIC LOOP.

The input connection is carried out through plug J1, and the loop output is made through plugs J2 or J6. (In the schematic, only the connection through the J2 plug has been represented.)

The power supply unit will be monitored, and will occupy a position in the algorithmic loop.

All the units connected in the algorithmic loop from the connection carried out in the output plugs will be fed from the Auxiliary Power Supply.

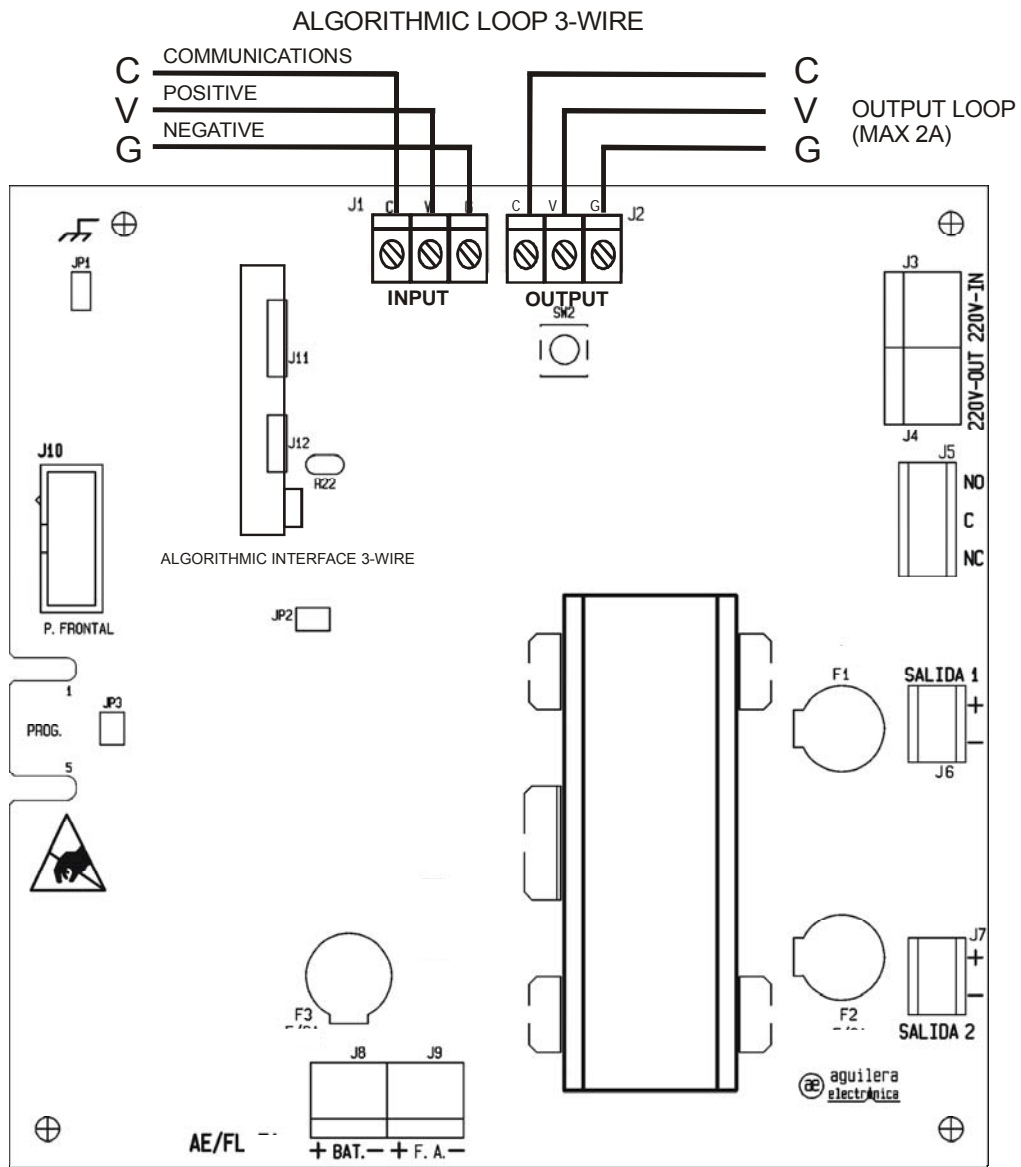

For the correct operation, it is necessary that the analogical module interface be mounted on the J11 and J12 connectors.

By means of selector 8 of the 3-wire algorithmic interface, it is possible to associate the state of this output with that of the input, so if there is no voltage at the input, or this falls below a certain level, the output is decoupled. (The other output is not affected.)

4.4.3 USED AS SUPPLY FOR 2 ALGORITHMIC LOOPS.

All the units connected in the algorithmic loop from the connection carried out in the output plugs will be fed from the Auxiliary Power Supply.

The power supply will be monitored, and will occupy a position in the 3-wire algorithmic loop connected to the J1 plug. The supply output for this loop is associated with OUTPUT 1, plugs J2 or J6 indistinctly. By means of selector 8 of the 3-wire algorithmic interface, it is possible to associate the state of this output with that of the input, so if there is no voltage at the input, or this falls below a certain level, the output is decoupled.

The second algorithmic loop will be connected on OUTPUT 2. It is necessary to unify the negatives of this second loop.

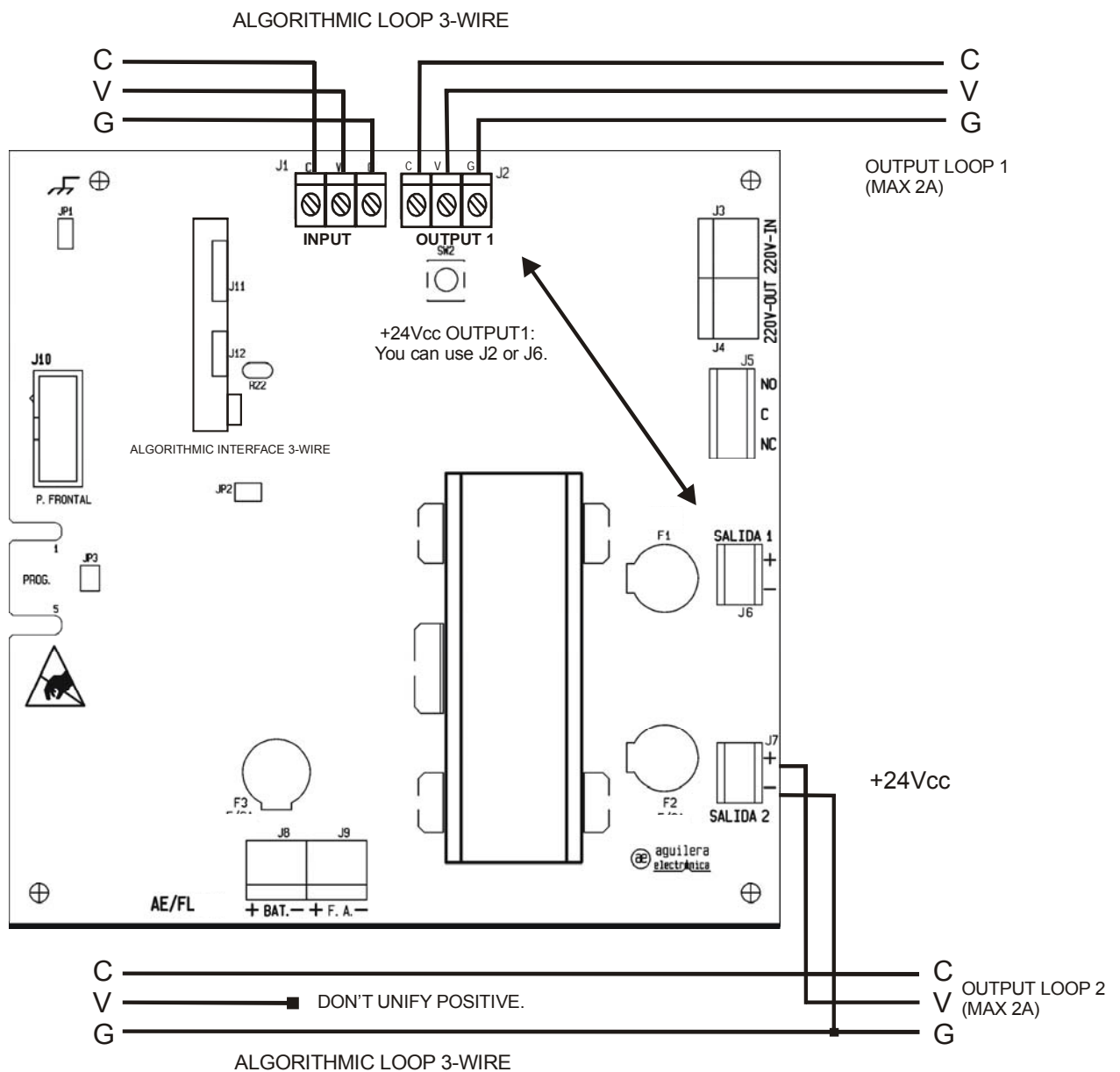

The output current in the algorithmic loop should not exceed **2.0 Amps**, to avoid problems in the communications caused by voltage drops in the wiring.

4.4.4 CODING

All the algorithmic units have to be coded with a number as corresponds to their personalization. This coding is carried out in binary, through the dilswitch located in the 3-wire algorithmic interface, programming a code number between 1 and 125.

The coding of the number is carried out with selectors 1 to 7.

Before connecting the panel to the algorithmic loop, verify it is correctly coded.

Once the extinguishing panel has been connected, check that it communicates correctly with the analogical fire panel. If this is not the case, check that the code of the panel corresponds to that of its personalization and review the connections to the analogical loop.

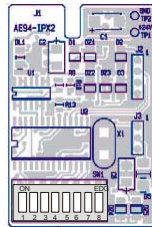

CODING AND OPERATING MODE

4.4.5 OPERATING MODE OF THE 3-WIRE ALGORITHMIC LOOP OUTPUT.

By means of selector number 8 of the dilswitch located in the interface, it is possible to modify the operation of the algorithmic loop associated with Output 1 of the Auxiliary Power Supply.

Position	Operation
ON	The positive of the Algorithmic Loop Output and Output 1 remain high.
OFF	The positive of the Algorithmic Loop Output and Output 1 are disconnected when the voltage at the input of the algorithmic loop is less than 16 volts.

This function allows the whole installation to be disconnected when the Algorithmic Fire Panel is switched off, or to leave part of the installation powered, in cases like the operations that require voltage continually, fire wall doors, air conditioning dampers, etc.

Output 2 is unaffected by the selected operating mode, and always remains activated.

5 OPERATION

The Power Supply Unit provides a voltage of 27.2V and a maximum current of 4.5A distributed in two independent, monitored and fuse-protected outputs.

It also incorporates a battery charger, capable of charging two 12-volt batteries connected in series and with a capacity of 7Ah or 17Ah.

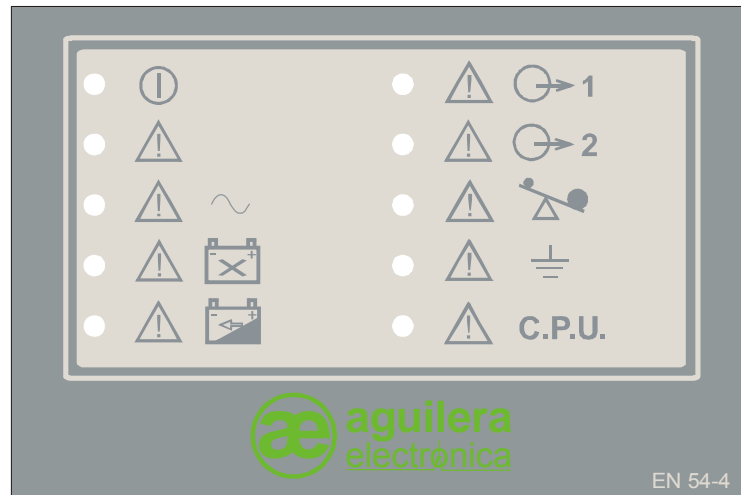

The indicator pilots, visible from outside the box, indicate all the possible fault states that can affect the power supply unit, and which are explained below.

5.1 SERVICE.

 An indicator lamp, green in colour, which indicates that the power supply unit is working. According to its activation mode, it indicates:

On	The control unit is powered and working.
Flashing	Supply voltage is low. The voltage supplied to the control circuit has fallen below 20.5V. Proceed to disconnect Outputs 1 and 2.
Off	The control unit is out of service. There is no mains voltage or batteries, or they are completely discharged.

5.2 GENERAL FAILURE.

 An indicator lamp, yellow in colour, which indicates the presence of a fault state in the Auxiliary Power Supply Unit.

There should be at least one other fault indicator illuminated.

The activation of the General Failure indicator causes, in turn, the actuation of the General Failure relay.

5.3 MAINS FAILURE.



An indicator lamp, yellow in colour, which indicates the absence of mains voltage (100V to 240V AC), necessary for the operation of the switched source as principal supply component. The installation and the control circuit are fed through the batteries.

When this fault condition occurs, the control circuit periodically activates the reset relay, disconnecting the mains voltage output from the main board to the switched source.

When the mains feed is restored, the mains failure indication is reset, but activation can take place of the charger fault indicator during the time that the reset relay remains enabled. This condition should disappear in a few seconds.

5.4 FAILURE OF BATTERIES.



An indicator lamp, yellow in colour, which indicates an anomalous situation in the batteries utilized as secondary supply element. The control circuit monitors the connection, the state of charge, and the internal resistance of the batteries.

According to its activation mode, it indicates:

On	<p>In operation with the mains (battery charging process), when the battery voltage falls below 26.5V</p> <p>In operation without the mains (battery discharging process), when the battery voltage falls below 21V.</p> <p>It can also indicate an anomaly in the batteries when their internal resistance has increased to more than 0.5Ω. The batteries should be replaced.</p>
Flashing quickly	There are no batteries, the battery voltage has fallen below 16V, the charger output is short-circuited, or fuse F3 has blown.
Flashing slowly	Battery test in process, the load connected to the Power Supply Unit outputs is only fed with the batteries during 10 seconds.
Off	Batteries connected and charged.

The battery fault indicator will not go out until they have reached an optimum charge level. The time necessary for charging the batteries can be up to 24 hours.

The battery charging circuit is protected by means of the 6-Amp fuse F3.

When the batteries are charged, a periodic 10-second test is carried out every 3 hours to measure their internal resistance. Activation of the battery fault indicator after running the test, or if it is maintained for more than 72 hours, means that the batteries are in poor condition and should be changed.

The life cycle of the batteries varies between 3 and 5 years, as well as on the version. Consult the information provided by the manufacturer of the batteries being used.

5.5 CHARGER FAULT.



An indicator lamp, yellow in colour, which indicates an anomalous situation in the switched supply source and the battery charger. According to its activation mode, it indicates:

- On The switched power supply unit is not delivering output voltage, or this is below 23.5V. It goes out if a mains failure is detected.
- Flashing Battery test process in execution, since the switched source is disconnected to feed the load only from the batteries.
- Off The switched source and the battery charger are working correctly.

5.6 OUTPUT 1 FAULT.



An indicator lamp, yellow in colour, which indicates an anomalous condition in Output 1. According to its activation mode, it indicates:

- On There is no output voltage, for failure of the fuse.
- Flashing Output disconnection, for low supply voltage level, or for excessive total current consumption in the power supply unit.

In the AE/94-FA version, with selector 8 of the AE/94-IFA interface in the OFF position, it indicates the disconnection of the output for absence of the analogical loop voltage.
- Out The switched source and the battery charger are working correctly.

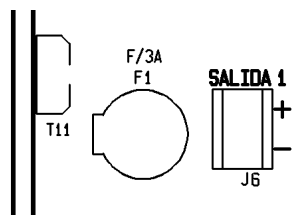

Output 1 is monitored and protected by means of fuse F1, limiting the current to 3A.

5.7 OUTPUT 2 FAULT.



An indicator lamp, yellow in colour, which indicates an anomalous condition in Output 2. According to its activation mode, it indicates:

- On There is no output voltage, for failure of the fuse.
- Flashing Output disconnection, for low supply voltage level, or for excessive total current consumption in the power supply unit.
- Off The switched source and the battery charger are working correctly.

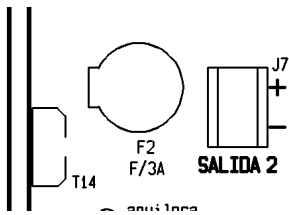

Output 2 is monitored and protected by means of fuse F2, limiting the current to 3A.

5.8 MAXIMUM CURRENT LIMIT.



An indicator lamp, yellow in colour, which indicates an anomalous condition in the current sensor, or the maximum output current has been exceeded that is allowed in the power supply unit. According to its activation mode, it indicates:

- On The maximum permitted current of 5.2A has been exceeded, adding the consumption of the two outputs and the battery charger.
- Flashing quickly The reference current level has not been established, or the control module has started up with battery voltage only. Outputs 1 and 2 remain disconnected.
- Flashing slowly The maximum permitted current of 4.5A has been exceeded. Only for information.
- Off Output current inside the permitted range.

The Power Supply Unit has a current sensor that is constantly measuring the consumption delivered from the switched power supply.

Although the maximum current allowed in the switched supply is 5.2 Amps in total, it is necessary to leave 0.7A in reserve for charging the batteries. The useful current that the Power Supply Unit can deliver is 4.5A.



For this reason the indicator begins to blink intermittently when the consumption exceeds the limit of 4.5A, demonstrating that the recommended current limit is being surpassed. This can be due to the sum of the consumption, inside the margins, plus the consumption for charging the battery.

If the total consumption surpasses 5.2A, the indicator comes on in permanent mode, and disconnection takes place of outputs 1 and 2 in order to not overload the switched source. The indicators of these outputs will be activated in intermittent mode.

Periodically a consumption test is carried out; if the limit is not exceeded in a given period of time, outputs 1 and 2 are reactivated.

If the Maximum Current Limit indicator remains activated in a fast intermittent mode, outputs 1 and 2 will remain disconnected, and there is no output voltage. Disconnect the batteries and check that it is being fed with mains voltage. If this indication persists, it is necessary to send the control module to the Technical Service for overhaul and calibration.

5.9 GROUND FAULT.

  An indicator lamp, yellow in colour, which indicates a shunt in the ground line. According to its activation mode, it indicates:

- On A shunt to earth has been detected, with the common negative of the Power Supply Unit.
- Off Ground line correct.

The AE/SA-FA and AE/94-FA Power Supply Units, connected to the algorithmic loops, can detect Ground Faults. If the Algorithmic Fire Panel is connected to a PC or printer, since these units join the common negative with the ground line.

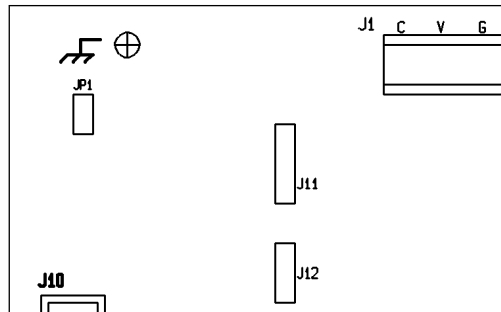

Ground Fault detection can be disconnected by removing the selector JP1

5.10 SYSTEM FAULT.

 **C.P.U.** An indicator lamp, yellow in colour, which indicates an operating failure of the control circuit

The control circuit will carry out a reset periodically; if the system fault LED remains on, it will be necessary to send the control module to the Technical Service for repair.

5.11 TEST.

By pressing the pushbutton SW2, located in the control circuit, a test is carried out of the indicator lamps and a check the battery condition, which is also carried out periodically and automatically every 3 hours.

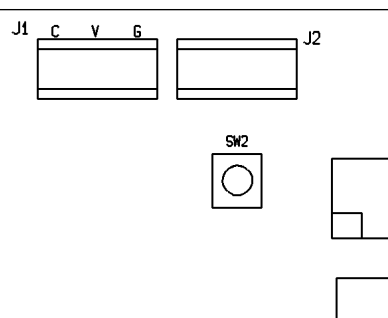

5.11.1 TEST OF INDICATOR LAMPS.

On depressing SW2, all the indicator lamps are activated for 2 seconds. Activation is also provoked of the system fault indicator, but without producing the reset of the Power Supply Unit.

5.11.2 BATTERY CHARGE TEST.

If the battery charge is correct, a test of the batteries is also carried out consisting in disconnecting the switched supply source for 10 seconds and feeding the entire load from the batteries. It is verified that the batteries provide sufficient current to feed the load connected in terms of their internal resistance, and that the battery voltage does not fall below 24V.

The battery charge test is carried out automatically every 3 hours.

You have to select R22 jumper in the correct position according to batteries type:

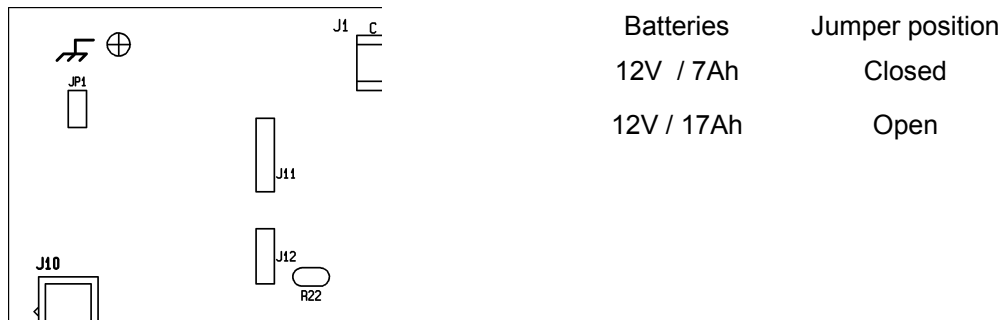

For the correct detection of the internal resistance, it is necessary that the power supply has a current consumption in the outputs of more than 1 Amp.

The Battery Fault and Charger Fault indicators will come on intermittently during the test process.

If the Power Supply Unit is in a fault condition, only the LED test is run.

The life cycle of the batteries varies between 3 and 5 years, as well as on the version. After this time their capacity diminishes and they should be replaced.

Consult the information provided by the manufacturer of the batteries being used.

6 TECHNICAL CHARACTERISTICS..

Size:

Width:	390 mm.
Height:	440 mm.
Depth:	100 mm.
Colour:	RAL 9002
Material:	Rolled AP 011 plate
Weight:	20 kg with batteries of 17Ah

Connection:

Cable infeed:	tube infeeds of 26 mm diam. removable window of 150 x 35 mm in the rear part
Cable section:	2.5 mm ² maximum

Power Feed:

Supply voltage:	230 V / 50 Hz.
Recommended cable:	H05 VV-F 3 X 1.5mm ²
Switched source voltage setting	28.2 V
Working voltage:	27.2 V
Supply voltage failure:	< 21.5 V > 29.5 V
Automatic disconnect:	< 20.5 V
Maximum current, source and charger:	5.2A.
Maximum output current	4.5A
Maximum current per output	3.0 A

Batteries:

Type of batteries:	2 sealed rechargeable lead-acid batteries of 12V / 17Ah (or 7Ah) connected in series.
Duration	Replace the batteries every 4 years.
Charging current:	0.05 C corresponding to - 350 mA maximum for 7Ah batteries. - 850 mA maximum for 17Ah batteries.
Charging voltage:	2.275 V per cell, 27.3 V in total
Discharged battery warning voltage:	< 21.0 V
Deep discharge battery voltage:	< 16.0 V
Battery condition check:	every 10 s
Battery test:	every 3 hours, for 10 s
Maximum internal resistance:	0.5 Ω.
Minimum current for measuring Ri	> 1A

Fuse:

Mains	Fuse, 2 A, in the mains connection plug
Batteries	Fuse, 3.15 A, in the switched power supply
Output 1	Fuse, 6 A, identified as F3 in base board
Output 2	Fuse, 3 A, identified as F1 in base board
	Fuse, 3 A, identified as F2 in base board

Indicator lamps:

General	<ul style="list-style-type: none">- Service.- General Failure.- Mains Failure.- Battery Failure.- Charger Fault.- Output 1 Fault.- Output 2 Fault.- Maximum current limit.- Ground Fault.- System Fault.
---------	---

Operating Controls:

Test Key	Test of indicator lamps. Test of battery charge.
----------	---

Relay outputs:

Fault state relay	NO, C and NC Contacts. Activated when idle.
-------------------	---

Integration in algorithmic system:

Algorithmic System, 2-wire	AE/SA-IFA Interface
Algorithmic System, 3-wire	AE/94-IFA Interface



YOUR NEAREST POINT OF ASSISTANCE AND SUPPLY

CENTRAL OFFICE

C/ Julián Camarillo, 26 – 2ª Planta – 28037 Madrid
Tel: 91 754 55 11

GAS PROCESSING PLANT

Av. Alfonso Peña Boeuf, 6. Pol. Ind. Fin de Semana – 28022 Madrid
Tel: 91 754 55 11

NORTHEAST OFFICE

C/ Rafael de Casanovas, 7 y 9 – SANT ADRIA DEL BESOS – 08930 Barcelona
Tel: 93 381 08 04

EAST OFFICE

Tel: 628 92 70 56

NORTHWEST OFFICE

C/ José Luis Bugallal Marchesi, 9 – 15008 – A Coruña
Tel: 98 114 02 42

SOUTH OFFICE

Edificio METROPOL 3 – C/ Industria, 5 3ª Planta Mod.17
Parque Industrial y de Servicios del Aljarafe (P.I.S.A.) – 41927 – Mairena del Aljarafe – Seville
Tel: 95 465 65 88

CANARIES OFFICE

C/ Sao Paulo, 17, 2ª Planta. Oficina 3-2-15. Urb. Ind. El Sebadal – 35008 Las Palmas de Gran Canaria
Tel: 928 24 45 80

<http://www.aguilera.es> e-mail: comercial@aguilera.es