



IST-1700.PA01.02/B  
File: IST-1700.PA01.02-B\_CE700-EN.docx

# CENTRAL SYSTEM

**CE700P**  
**CE700R**

**USER'S MANUAL**

**TECNOCONTROL S.r.l.**

Via Miglioli, 47 20090 SEGRATE (MI) Italy- Tel. (+39) 02 26922890 - Fax (+39) 02 2133734  
http: [www.tecnocontrol.it](http://www.tecnocontrol.it) e-mail: [info@tecnocontrol.it](mailto:info@tecnocontrol.it)

## IMPORTANT NOTE

**Please read and keep care of this manual  
and the manual of installed sensors too.**

## ***INFORMATION AND WARNINGS OF USE***

All documentation relating to gas detection plant should be preserved, because it contains the procedures to be used during the routines verification and / or during the periodic calibration.

We recommend that you always complete the [Setup Memorandum Tables](#) in [pages 26 and 27](#). This will facilitate any possible change to the configuration and / or in case of additional sensors.

The central unit, at power, performs an integrity check of the configuration and performs, if necessary, an automatic recovery of the configuration. In the rare case a fatal error occurs, the display will show "*Configuration lost!*" and will activate the buzzer. To correct this problem, turn off and on the central and if necessary re-insert the configuration using the [Configuration Memorandum Tables](#), which as suggested above, must be compiled during installation and updated in case of changes.

## **WARNING**

The Central has a clock with the automatic DST change.

In the absence of power supply, the clock works with the 3V (CR2032) lithium battery (on the main board). Its life, in normal operation is over 5 years.

If the lithium battery is exhausted and the central remained completely without power, at start up, you will need to enter the correct date and time ([see on page18](#)) and then the battery must be replaced soon with a new one.

<b>Documento / Document name:</b> IST-1700.PA01.02-B_CE700-EN.docx			
<b>Oggetto / Subject :</b> CE700 Central Unit (max no.184 Gas Detectors)			
Rev.	Data / Date	Da / By	Note
A	15/12/2009	UT/FG	Aggiornato per FW per ID170/DG2005
B	14/01/2015	UT/FG	Adding Screen "STATUS ALARMS AND ACTIVE FAULTS"

## CONTENTS

<b>DESCRIPTION</b>	<b>4</b>
<b>CENTRAL SYSTEM MONITORING</b>	<b>7</b>
<b>CE700P INSTALLATION INSTRUCTIONS</b>	<b>9</b>
<b>CE700P CENTRAL UNIT ELECTRICAL CONNECTIONS</b>	<b>9</b>
<b>CE700R INSTALLATION INSTRUCTIONS</b>	<b>10</b>
<b>CE700R CENTRAL UNIT ELECTRICAL CONNECTIONS</b>	<b>10</b>
<i>CE700P CENTRAL UNIT CONNECTION WITH THE CE380UR REMOTE UNITS</i>	<i>11</i>
<i>CE700R CENTRAL UNIT CONNECTION WITH THE CE380UR REMOTE UNITS</i>	<i>12</i>
<i>CONNECTION WITH TRANSMITTERS</i>	<i>13</i>
<b>CENTRAL UNIT SETUP</b>	<b>13</b>
<i>KEYBOARD USE AND GENERAL INFORMATIONS</i>	<i>13</i>
<i>SENSORS SETUP</i>	<i>14</i>
<i>SENSOR DELETION</i>	<i>15</i>
<i>COPY SENSORS</i>	<i>15</i>
<i>SENSORS ENABLING AND DISABLING</i>	<i>16</i>
<i>MODIFYING THE SENSORS SETUP</i>	<i>16</i>
<i>BOARDS SET UP (Remote Units CE380UR)</i>	<i>16</i>
<i>OUTPUTS SETUP</i>	<i>17</i>
<i>OUTPUT DELETION</i>	<i>17</i>
<i>AREAS SETUP</i>	<i>18</i>
<i>LANGUAGE</i>	<i>18</i>
<i>CLOCK ADJUST (TIME AND DATA)</i>	<i>18</i>
<i>SUMMER TIME</i>	<i>18</i>
<i>HOW TO DISPLAY DATE AND HOUR</i>	<i>19</i>
<i>MAINS BLACKOUT AND SERIAL LINE FALIURE</i>	<i>19</i>
<i>SERIAL PORT SET UP</i>	<i>19</i>
<i>TABLE CODES FOR SET UP THE MODEM</i>	<i>19</i>
<i>DESCRIPTION OF THE MODBUS COMMUNICATION</i>	<i>20</i>
<i>PASSWORD SETTING</i>	<i>20</i>
<i>PRINTING (This key not be used in this version)</i>	<i>20</i>
<i>EVENTS VISUALISATION</i>	<i>21</i>
<i>EVENTS DELETION</i>	<i>21</i>
<i>CENTRAL UNIT HARDWARE TEST</i>	<i>22</i>
<b>APPENDIX</b>	<b>23</b>
<i>CE700 TECHNICAL SPECIFICATIONS</i>	<i>23</i>
<i>WARNINGS AND FAULT MESSAGES LIST</i>	<i>23</i>
<b><u>TABLE 1</u> - 4÷20 mA PRECONFIGURED GAS DETECTORS LIST</b>	<b>24</b>
<b><u>TABLE 2</u> - RECOMMENDED TLV VALUES (for Toxic Gases)</b>	<b>25</b>
<i>SETUP MEMORANDUM TABLE</i>	<i>26</i>

## DESCRIPTION

The CE700 series gas Central Systems is as useful instruments for monitoring and controlling areas to be protected from flammable gas leakage and with the presence of toxic gases. Together with TECNOCENTROL gas detectors they can control quite large areas where up to 184 detectors can be installed.

This manual describes the CE700 series Central System functions, monitoring procedures of the system made by the user and the setup procedure, as well as installation and test procedures to be carried out only by authorised personnel.

The CE700-series Central Systems are composed by a front unit for the data processing with backlighted display 40x2 characters, foil keyboard, input/output units and power supply. The CE700 are standard AC powered (230Vac–50Hz). It can also accommodate one 12Vdc battery connection to assure the system powering in case of mains blackout (not included in delivery).

The CE700-series are designed to be linked to SW700 Management Software for PC or other device connected to the serial port ([see on page 7](#)).

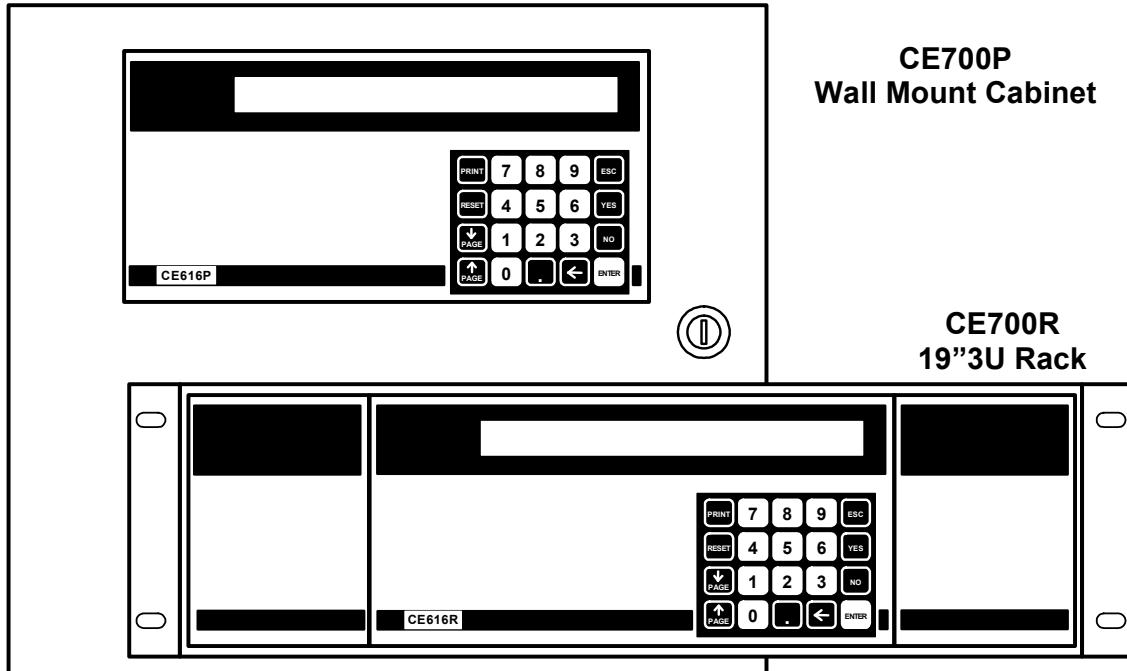

- **The CE700-series Central Units have various models:**

**CE700P series in metal wall-cabinet** 360x300x100mm are:

**CE700R series three units 19" Rack module, are:**

- **The CE700-series Central Units can be connected up to 23 CE380UR:**

Each CE380UR, has 8 inputs 4÷20mA and can be fitted as required to install up to two cards ES380UR each with 4 relay outputs. The CE700 can then handle up to 184 sensors and relay outputs, all addressable by the program.

- **The CE700-series through CE380UR Remote Units, can be connected to all of our Gas Detectors (Sensors):**

- Three-wire, 4÷20mA linear transmitters with "Replaceable Cartridge Sensor" for:

Flammable gases with Catalytic sensor TS292K(IP65) or TS293K(Ex"d") series with 0÷20%LEL range.

Flammable gases with Pellistor sensor TS292P(IP65) or TS293P(Ex"d") series with 0÷100%LEL range.

Flammable gases with Infrared sensor TS293I(Ex"d") series with 0÷100%LEL range.

Toxic gases with electrochemical cell TS220E (IP65) or TS293E (Ex"d") series.

Carbon dioxide with Infrared sensor TS210IC2 (IP54), TS220IC2 (IP65) or TS293IC2 (Ex"d").

Oxygen with electrochemical cell TS220EO or TS293EO (Ex"d") with 0÷25%O<sub>2</sub> range.

Parking with dual sensor TS255CB or TS255CN2

**NOTE:** May be connected, even the old models. Detectors three-wire 4 to 20mA linear for flammable gases or those two-wire 4 to 20mA linear for toxic gases or oxygen, produced until December 2008. Or the IR101 or IR102 for CO<sub>2</sub> in production until December 2014.

**WARNING:** inputs are configurable for 4÷20mA transmitters with reported current to ground and operating characteristics same as our products (unit in %LEL or ppm, minimum operating voltage, absorption, load resistance etc.). **We accept no liability for malfunctions or failures caused by not compatible products.**

- **The INPUTS (remote gas detectors) can be grouped in AREAS:**

The inputs can be grouped in **Areas** (max 25), for which, up to five different outputs can be configured for each alarm levels, plus one output for the Fault. For each area the output activation can be executed also when the mean value of the area-grouped input exceeds an alarm level.

- **Each INPUT (remote gas detectors) can be associated to a WEIGHY:**

Each input alarm level can be associated to a **Weight** (max value = 10) for the realisation of logic AND among more inputs of the same area.

**Example:** *the output 1 can be associated to both level 1 of two inputs with weight 5 and level 2 with weight 10. Should this be the case, the output 1 will be activated if both the inputs exceed the 1st alarm level and one of the two sensors exceeds the 2nd alarm level.*

- **Each INPUT (remote gas detectors) is self-protected and has a FAULT signal:**

All detectors inputs are protected against short-circuit or wire breakings. If a short-circuit occurs, the power supply to that input, is automatically stopped (all others continue to work properly). Simultaneously the FAULT signal is activated. Only after having solved the problem, it will be possible to restore normal operational conditions, by the "RESET" key. The display shows the Sensor Fault with the written FAULT flashing.

- **Each INPUT (remote gas detectors) can be set-up with TLV alarms:**

**TLV** (Threshold Limit Values) are defined as an exposure limit to which it is believed nearly all workers can be exposed day after day for a working lifetime without ill effect.

**TLV-TWA** (Threshold Limit Value – Time-Weighted Average) is the time-weighted average concentration for a conventional 8-hour workday and a 40-hour workweek, to which it is believed that nearly all workers may be repeatedly exposed, day after day, without adverse effect.

**TLV-STEL** (Threshold Limit Value – Short-Term Exposure Limit) is the concentration to which it is believed that workers can be exposed continuously for a short period of time without suffering from irritation, chronic or irreversible tissue damage, or narcosis. STEL is defined as a 15-minute TWA exposure, which should not be exceeded at any time during a workday.

**TLV-C** (Threshold Limit Value - Ceiling) is the concentration that should not be exceeded during any part of the working exposure.

The values are recommending exposure levels that are protective to workers, **OSHA** (Occupational Safety and Health Administration, of the U.S. Department of Labour) and **COSHH** (Control Of Substances Hazardous to Health in Europe).

- **The CE700-series Central Units have alarm relays outputs into CE380UR:**

For each **Detector** (Input) three alarm levels (**Level 1** (PREalarm1), **Level 2** (PREalarm2) e **Level 3** (ALarm)) plus the **Fault** are available and addressable to whatever output installed into the CE380UR Remote Unit. The outputs consist of relays with tension free contacts.

Besides it is possible to assign a **mains blackout output**, usable to inform about the mains blackout and that the buffer batteries (if installed) have intervened. Also you can assign a **communicate failure output** to communicate a Remote Units CE380UR off-line condition or a failure of the serial line.

- **Each OUTPUT (relays) can be set-up as follows:**

- **Delay ON:** with a 250 seconds' delay when the input exceeds the set alarm level.

- **Delay OFF:** with a 250 seconds' delay when the input decrease below the set alarm level.

- **Activation ON:** with 250 seconds' activation time and then comes back independently of the input conditions (even if the input remains over the alarm level). (It has not to be used if the "Delay OFF" has been already inserted). For instance it can be used for activating devices that are not able or they have not to remain fed for a long time, or to send an impulse to a telephone combiner, or to other device.

- **LOGIC.** the relay contact position, can be set-up in **Positive Logic**, the relay is normally activates, in case of power-cut or fault of the relay it comes in alarm position. Or can be set-up in **Negative logic**, the relay is normally deactivated.

- **Latched output:** if no "Activation ON" time has been set, a relay can be latched so as it keeps activating even if the input comes back under the corresponding alarm level. Press the "RESET" key to come back to the normal function a memorized output.

- **The CE700-series Central Units have a BUZZER:**

The internal **Buzzer** sounds a **Bip** every touch of the keyboard.

- **The CE700-series Central Units can store the Events:**

the system can store up to 999 events comprising Alarms, Faults, Starting, Mains blackout, Resetting, that can be re-called at every time.

- **The CE700-series Central Units are PASSWORD protected:**

moreover, it is possible to protect all the configuration value by a code (min. 1 max 8 numbers).

• **The CE700-series Central Units have one RS232 and one RS485 Serial Port:**

**The RS485 (COM2)** Serial Port, normally be used to connect up to 23 Remote Units CE380UR (Fig. 1). Other explanations also page18, chapter **SETTING SERIAL PORTS**.

**The RS232 (COM1)** Serial Port can be used to connect the CE700 with:

- 1) a local PC on which you install our Software Management SW700 (Fig. 1). This software can manage one or more central CE700. Record events, the values of the sensors, can export stored values, can send e-mail in case of alarms and act as the central remote control.
- 2) or via RS232/Ethernet may be connected to local LAN, it is connected to one or more PCs to be installed on which our Software Management SW700 (Fig. 2).
- 3) or other management software, via MODBUS.
- 4) or modem (GPRS) mobile phone to send an SMS if an alarm occurs, a fault etc.
- 5) or a panel printer (optional)
- 6) or the Remote Display Unit CE700UR
- 7) or with CE380UR via RS232/RS485 converter CE395CS model (Fig. 3).

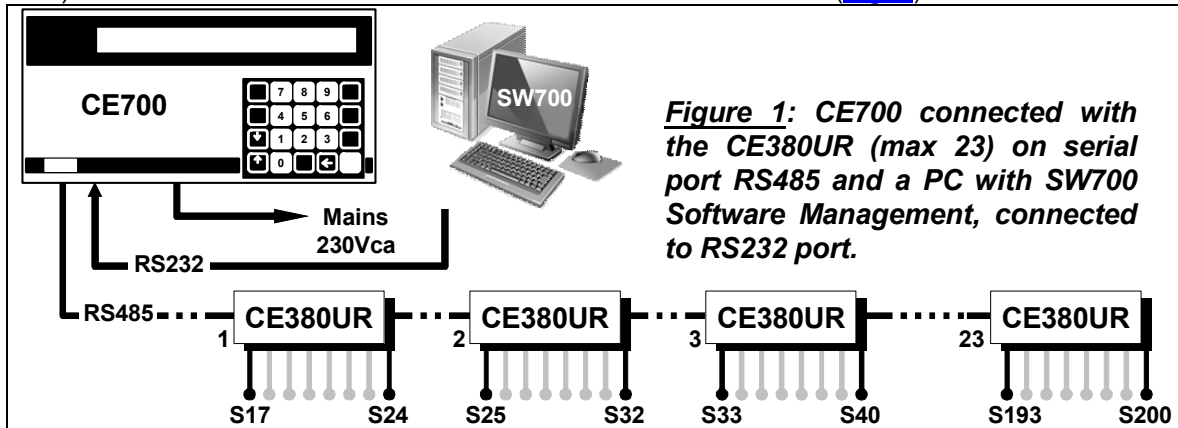

**Figure 1:** CE700 connected with the CE380UR (max 23) on serial port RS485 and a PC with SW700 Software Management, connected to RS232 port.

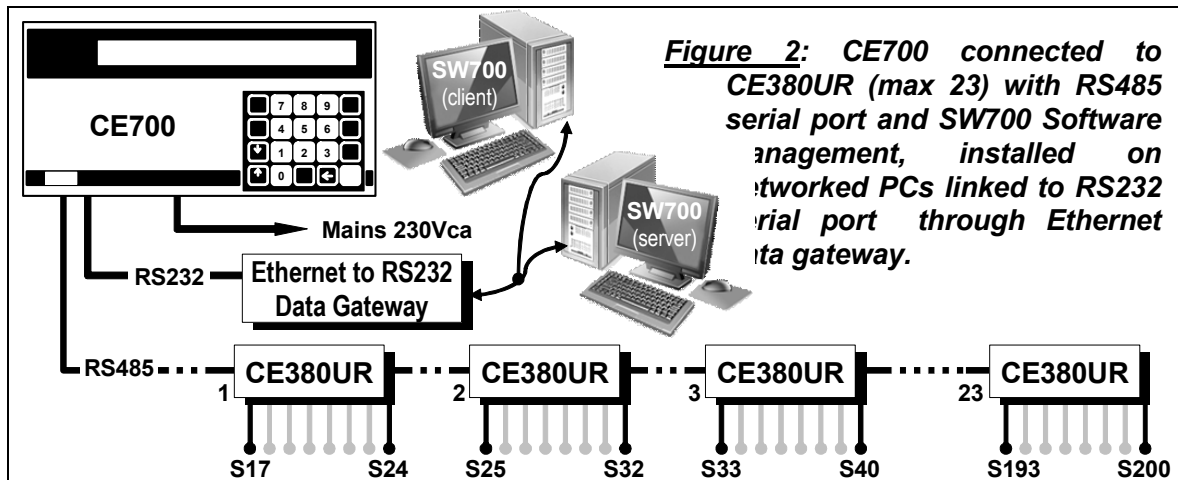

**Figure 2:** CE700 connected to CE380UR (max 23) with RS485 serial port and SW700 Software management, installed on networked PCs linked to RS232 serial port through Ethernet data gateway.

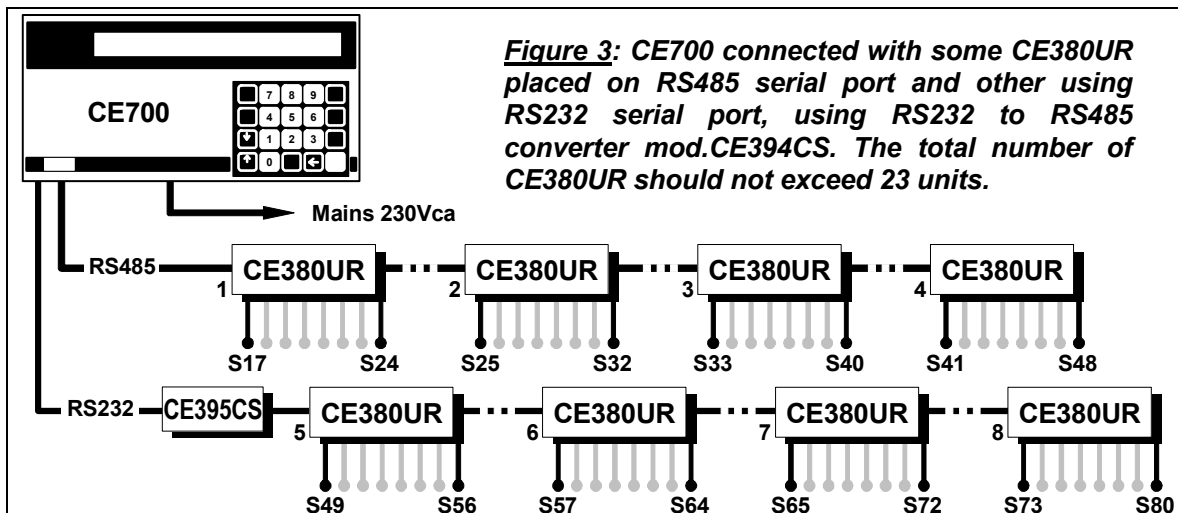

**Figure 3:** CE700 connected with some CE380UR placed on RS485 serial port and other using RS232 serial port, using RS232 to RS485 converter mod.CE394CS. The total number of CE380UR should not exceed 23 units.

## CENTRAL SYSTEM MONITORING

### • Keys:

**RESET** it is used to reset the latched outputs when the sensor(s) alarm cause has been called off. Or to reset a sensor powering when a signal short-circuits occurs.

**PRINT** to enter in print menu (if the Printer is installed), event visualisation and deletion, confirm alphanumerical characters insertion.

**↑ PAGE** and **↓ PAGE** to scroll on the display the configured sensors (in groups of four each screen).

**.** to show on the display Hour, Date and Mains conditions.

**ENTER** to confirm and, with normal view, to have a mA indication for the sensors' input.

**0** ÷ **9** numerical keys.

**ESC** to delete an operation and to enter into Mina Setup menu.

**YES** and **NO** to confirm and insert the alphanumerical characters in phase of configuration. In addition, the **YES** key is also used to call up the " **Status of active Alarm and Faults**".

**NOTE: the label with serial number is inside the door, on lower left part.**

### • Display

When powered, the CE700, after the incoming message, the 90 seconds' Wait message appears, to allow the sensor's stabilisation thus avoiding undesired conditions of false alarm.

After completing the waiting time, the Central Unit will display the current conditions of the first four connected sensors.

Use **↑ PAGE** and **↓ PAGE** keys to scroll the other configured sensors (always on group of four).

With this screen displayed, press **ENTER** key to have mA indication of the input. ----->

Press again the **ENTER** key to come back to the previous screen.

When either one or the other screens are displayed, press the **.** key to have Hour, Date and Mains Conditions (MAINS ON or MAINS OFF) : ----->

Press **.** key again to come back to the previous screen.

It is possible to access to a detailed input screen pressing the **1** key. The input detailed level is as follows: ----->

CE700 – 3.0 - by TECNOCONTROL

Wait . . . 90

1: 0.0%LIE NORM    2: 4ppm NORM  
3: 1.0%LIE NORM    4: 2ppm NORM

1: 4.0mA                    2: 4.6mA  
3: 4.8mA                    4: 4.8mA

20-09-2009 11:57:05  
MAINS ON

1: TS292KM [0.0-20.0] %LIE Z01  
18%LIE AL3 20mA 01 02 03

On the *1st row* is indicated the sensor number, model, range, unit of measurement and the area the sensor belongs to. In the *2nd row* is indicated the current measure, condition, mA value and the relays number corresponding to the three alarm levels, if activated.

Press **↑ PAGE** or **↓ PAGE** keys to display the other configured inputs. Then press **ESC** to return to the normal display screen, if pressing again **ESC** it is possible to enter into the Set-Up Menu (protected with password, if inserted).

### • Reset

Press **RESET** key the outputs (relay) and the corresponding signals flashing on the display, returns to its normal operating condition, but only if the sensor is returned by the alarm condition.







- **Status of active Alarms and Faults**

The Central has a screen that shows the summary of the status of alarms and faults active. This screen appears automatically when a sensor exceeds one of the set alarm levels.----->

<b>ACTIVE ALARMS AND FAULTS</b>			
<b>AL 1: 0</b>	<b>AL 2: 1</b>	<b>AL 3: 2</b>	<b>FAULT: 0</b>

From this screen, by pressing  **PAGE**, you see the sensors in alarm and / or failure sorted according to the importance of the alarm (first those AL3, then AL2 and AL1 and finally the FAULT).----->

<b>31: 20%LEL AL3</b>	<b>12: 50ppm AL3</b>
<b>3: 10%LEL AL2</b>	

The sensors in alarm and / or in fault, are displayed 4 per page, if there are other sensors, can be displayed with the  **PAGE** and  **PAGE** keys, that allow you to scroll through the other pages. Also in this screen, you can view the mA by pressing  or the details of a sensor by pressing  or  or  or , you enter the detailed display of the inputs as described on the previous page.

Press  key to come back to the previous screen.

The same screen can be called when needed. From the **Normal View**, pressing the  key, will display the status of the active alarms and faults as described above.



**WARNING: THE FOLLOWING INSTRUCTIONS DESCRIBES ALL THE CENTRAL SYSTEM SETUP PROCEDURES AS WELL AS THE INSTALLATION PROCEDURES TO BE EXECUTED ONLY BY AUTHORISED AND EXPERIENCED PERSONNEL.**

## CE700P INSTALLATION INSTRUCTIONS

This central should be wall mounted by fixing the cabinet, in vertical position, by the four holes that are in the corners of the back panel. (Fig. 4) The wiring connections should be executed all on the back panel and on the power supply. The main power supply (230Vac – 50Hz) should be connected to the terminal of the power supply (Fig.6).

Inside the CE700P cabinet, it can also accommodate a 12V/7Ah Pb battery connection (see Fig.5 and Fig.6) to assure the system powering in case of mains blackout.

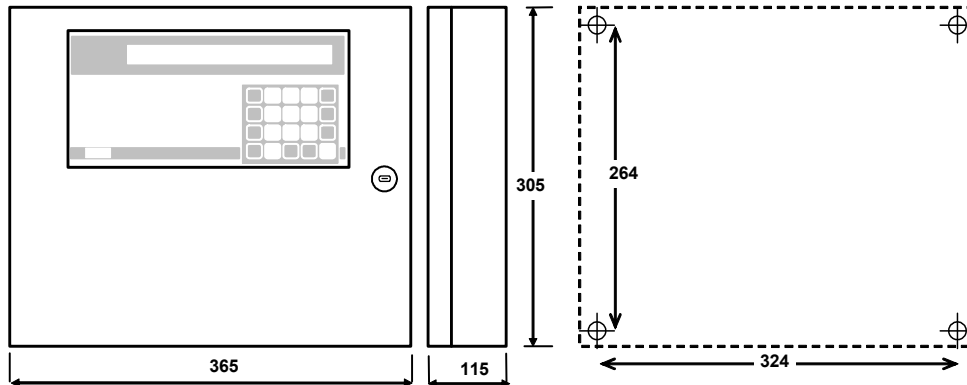

Fig 4 – CE700P Dimensions

## CE700P CENTRAL UNIT ELECTRICAL CONNECTIONS

Connections should be made inside the cabinet, as shown below in Fig. 5.

The 230V mains should be connected to L, N and Earth Power Supply terminals.

The Pb 12V/7Ah battery, if required, must be connected to Power Supply cables Red "BAT +" and Black "BAT-".

The connection to the serial ports is carried on board mounted on the cabinet door. The details of the link is shown in Fig. 8 on page 11.

The RS485 serial port COM2 is the (1) polarized terminal (Fig. 6), we recommend using appropriate lugs to the wires (2) and anchor cables to the structure to avoid excessive stress to the circuit and the terminals themselves.

The RS232 serial port COM1 is the DB9 male connector (terminal 2-Rx, Tx and 3-5 GND).

Fig 5 – CE700P internal view

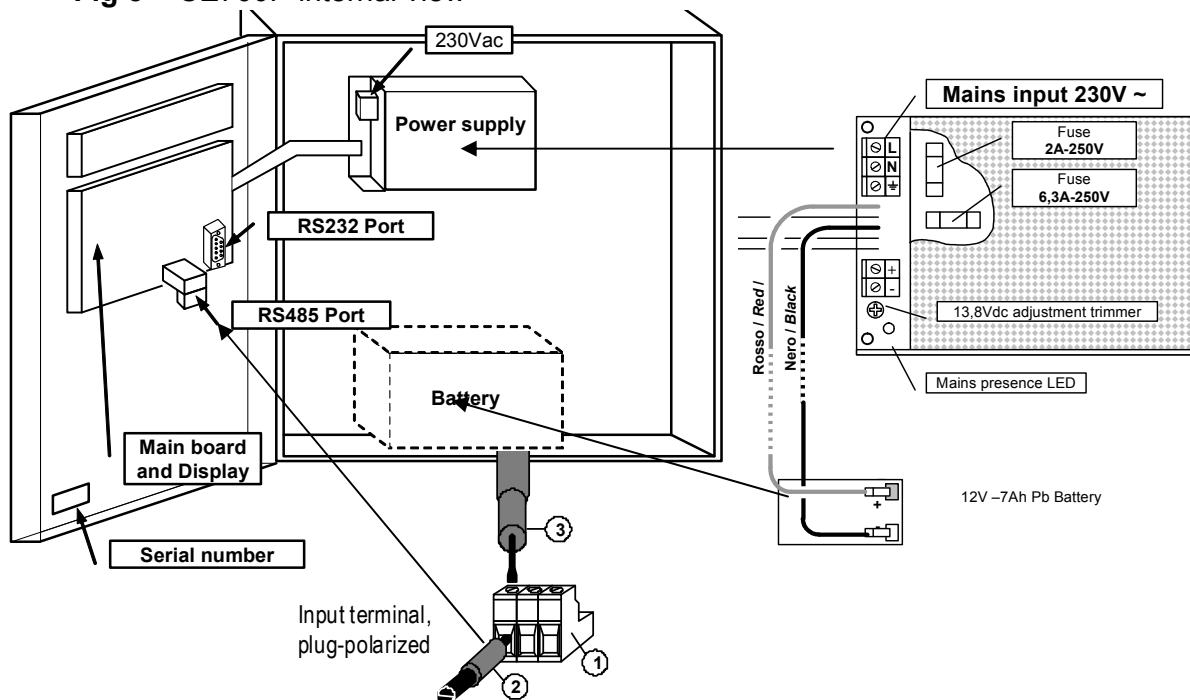

## CE700R INSTALLATION INSTRUCTIONS

This central should be mounted into a 19" rack cabinet (min. dimensions 3 units). The wiring connections should be executed on the rack back panel.

The mains power supply (230Vac – 50Hz) should be connected to indicate plug ([Fig.7](#)).

The **12V/7Ah Pb batteries** (if present) should be connected to **BAT+** (Red) and **BAT-** (Black) terminals ([Fig.7](#)).

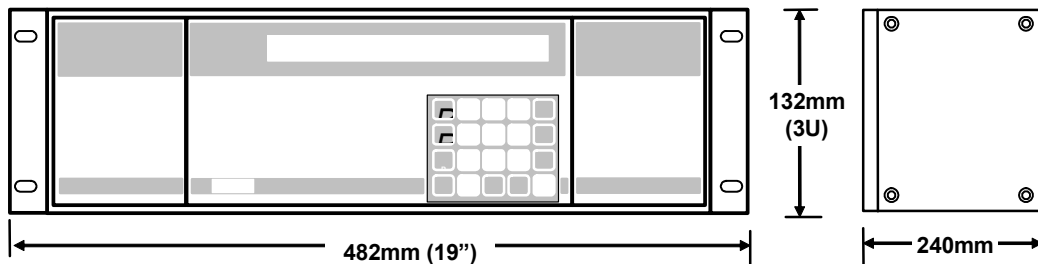

Fig 6 –CE700R Dimensions

## CE700R CENTRAL UNIT ELECTRICAL CONNECTIONS

The connections should be made on the back of the rack, as shown below in [Fig. 6](#). We suggest to fix the wires to the box structure to avoid excessive stress to the terminals.

The 230V mains should be connected to the C14 socket, using a 3-pin plug cable C13 type.

The Pb 12V/7Ah battery, if required, should be connected to BAT + (red) and BAT-(Black).

The serial ports connection should be made on DB9 male connectors on the rack back panel. The details of the link is shown [in Fig. 9 on page. 12](#).

The **COM1** is a RS232 serial port (terminal 2-Rx, Tx and 3-5-GND) and the **COM2** is a RS485 serial port (terminal 1-H, 6-L and 5-COM).

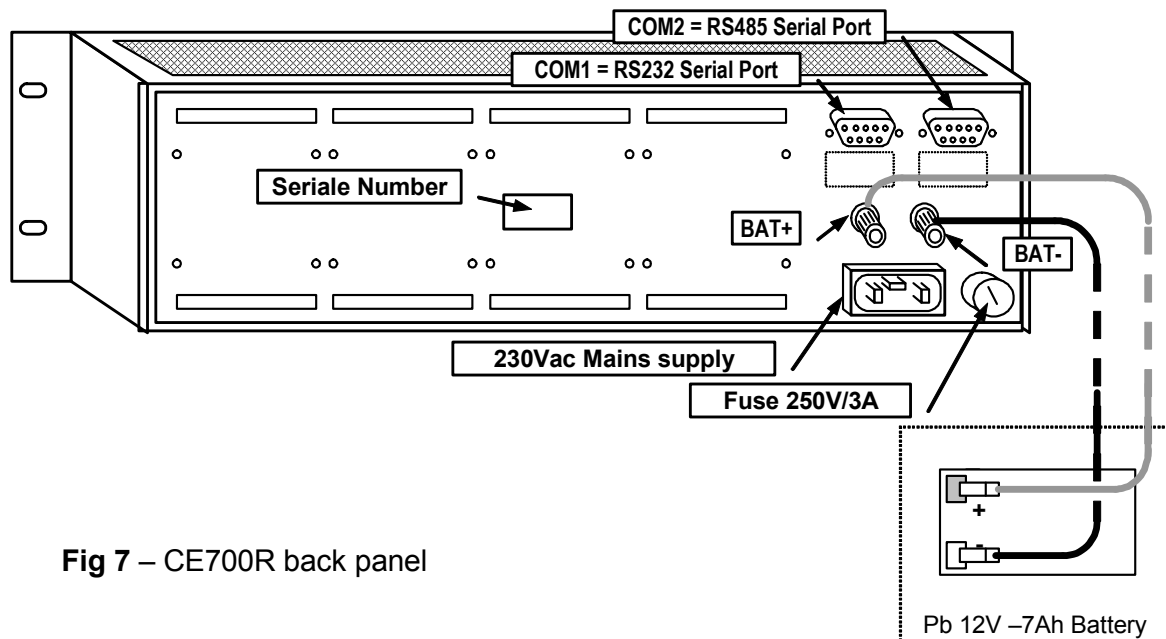

Fig 7 – CE700R back panel

### CE700P CENTRAL UNIT CONNECTION WITH THE CE380UR REMOTE UNITS

The CE700P Central Unit can be connected to a maximum of 23 remote units CE380UR.

**The cable should be used** is a three-wire shielded section of not less than 0.35 mm<sup>2</sup>. The maximum distance to connect the last remote unit CE380UR is 1 Km.

**The connection** should be made between the serial port COM2 RS485 (three poles terminal), on the board mounted in the CE700door and the terminal of the first CE380UR remote unit, then between the first remote unit and terminal of the second remote unit, and so on until the last CE380UR remote unit. (See below fig.8).

CE700P	CE380UR
Terminal CN12/RS485 Pole A	Terminal RS485 Pole H
Terminal CN12/RS485 Pole B	Terminal RS485 Pole L
Terminal CN12/RS485 Pole C (COM)	Terminal RS485 Pole GND

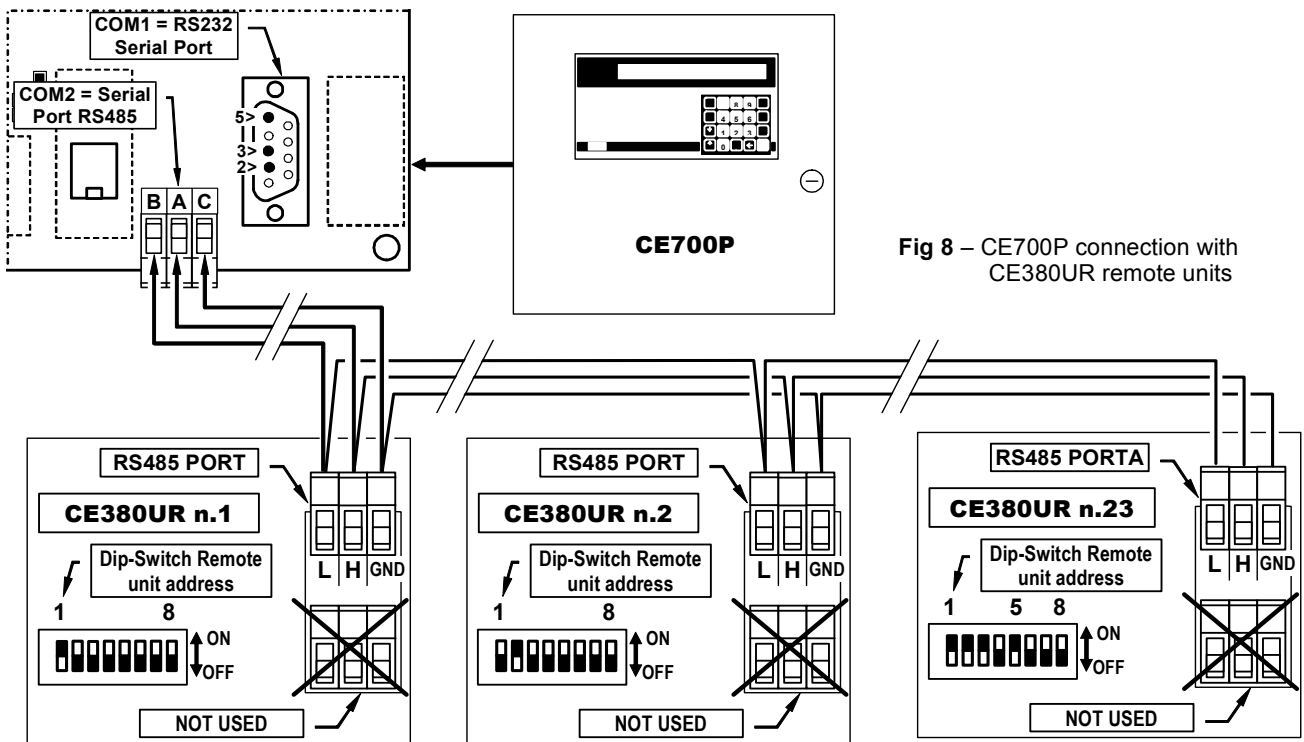
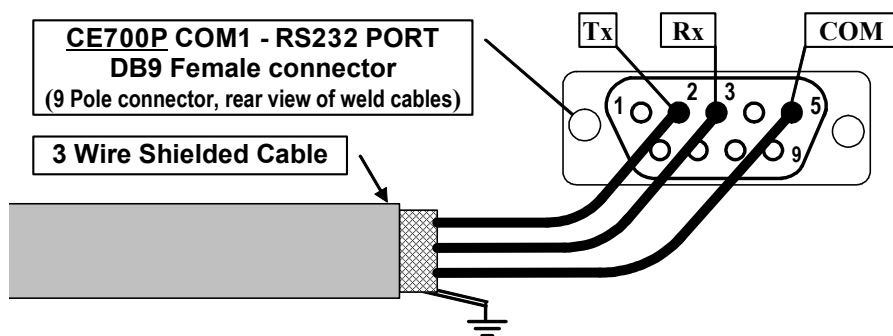

Fig 8 – CE700P connection with CE380UR remote units



### CE700R CENTRAL UNIT CONNECTION WITH THE CE380UR REMOTE UNITS

The CE700R Central Unit can be connected to a maximum of 23 remote units CE380UR.

**The cable should be used** is a three-wire shielded section of not less than 0.35 mm<sup>2</sup>. The maximum distance to connect the last remote unit CE380UR is 1 Km.

**The connection** should be made between the **COM2 serial port RS485** (DB9 male connector), on the CE700R back panel and the terminal of the first CE380UR remote unit, then between the first remote unit and terminal of the second remote unit, and so on until the last CE380UR remote unit.

The **COM2 Serial Port RS485**, is on the CE700R back panel. Using the DB9 female connector, soldered to pin 1 signal **H** (HIG) to pin 6 signal **L** (LOW) and to pin 5 to the **Ground**. (See below fig.9).

CE700R	CE380UR
Connector B / Porta RS485 Pin 1 <b>H</b>	Terminal RS485 Pole <b>H</b>
Connector B / Porta RS485 Pin 6 <b>L</b>	Terminal RS485 Pole <b>L</b>
Connector B / Porta RS485 Pin 5 <b>COM</b>	Terminal RS485 Pole <b>GND</b>

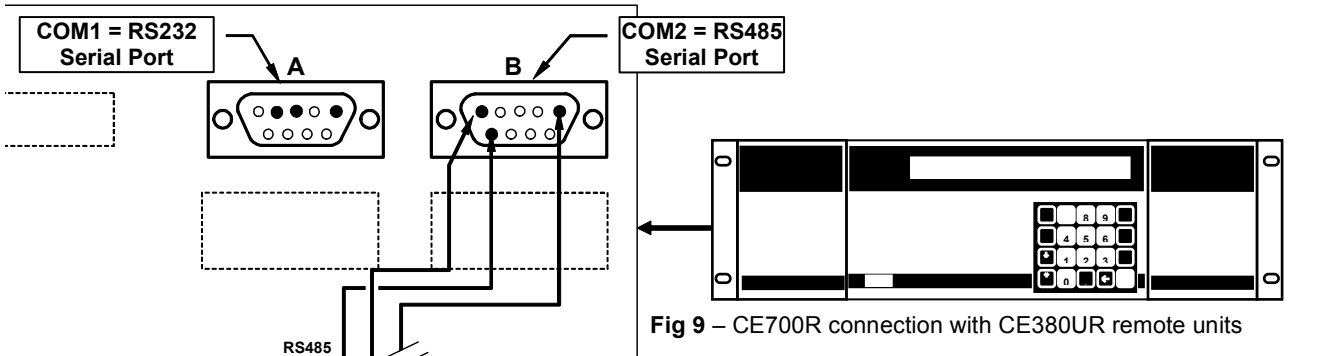
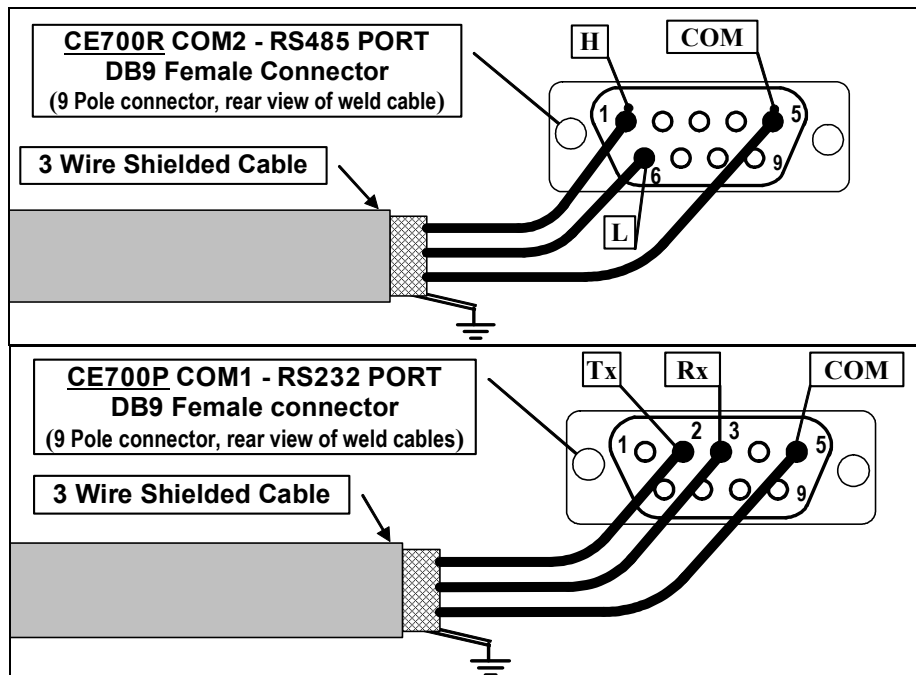
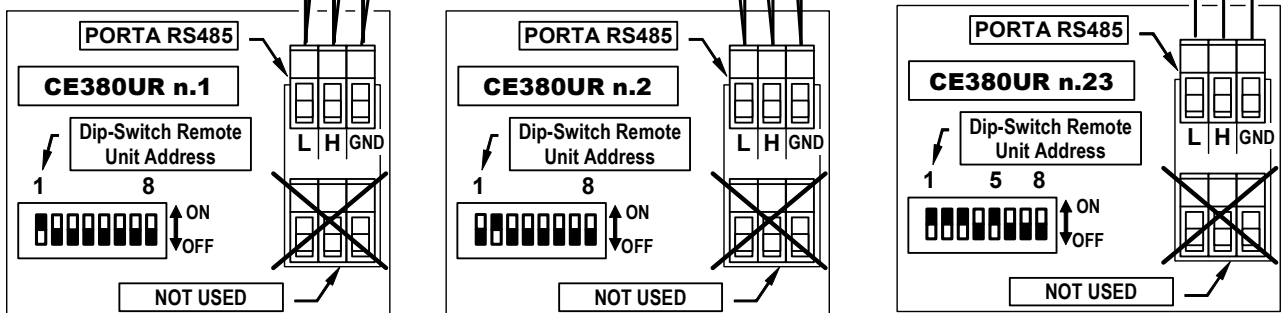

Fig 9 – CE700R connection with CE380UR remote units



## CONNECTION WITH TRANSMITTERS

**ATTENTION:** Please see the specific Users Instructions of the CE380UR remote Unit and the documentation attached to the Transmitters.

The connection with three-wire 4÷20mA transmitters should be carried out on the CE380UR inputs terminals. The connection wire section between the Central Unit and the sensors should be suited to the distance, as shown in the CE380UR user's manual.

## CENTRAL UNIT SETUP

**At the first set up**, after the first message, and after the waiting 90 seconds' count down, the following message will be displayed----->:





20-09-2009 11:57:05  
No Configured sensors.

Should more sensors has just been configured, it will display the current condition of the programmed sensors. -->





1: 0.0%LEL NORM    2: 4ppm NORM  
3: 1.0%LEL NORM    4: 2pp NORM

## KEYBOARD USE AND GENERAL INFORMATIONS

The alphanumerical texts changeable or to insert are displayed by using the *slider* (black flashing rectangle). To modify or insert a text have to be used

The  key to cancel leftwards the characters, the *slider*  e  key to select the characters and  key to confirm each selected characters.

**CHARACTERS:**    A÷Z [ ] a÷z Space ! “ # \$ % & ‘ ( ) \* + , - . / 0÷9 : ; < = > ? @

**Example:** if the text displayed have to be change (max 9 characters) from **TS293Px** into **TS293PB**, it is necessary to cancel the “X” with  key and press repeatedly  key until the letter “B” appears, after that, press  key to accept the inserted characters. Then, press  key to confirm.

Main menu

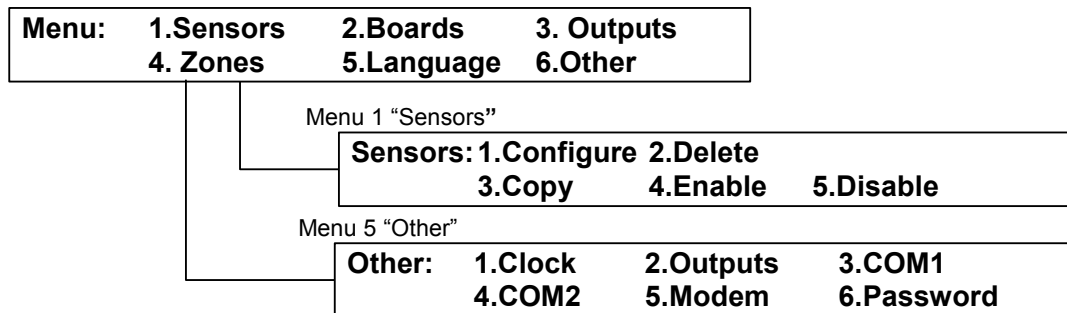

## SENSORS SETUP

**ATTENTION VERY IMPORTANT NOTE:** at the end of the Setup, always restart the Central Unit to allow setting the outputs (relay) as configured. This must be done every time you change the configuration.

Press **ESC** key to access to the *main menu*, after press **1** key to access to the *menu "1-Sensors"* and again the **1** key "*1-Configure*" to display: ----->

Digit the sensor number which corresponds to sensor-connected input number and then, press **ENTER** to confirm.

Sensor number [1-16] : \_ \_

Sensor number [1-16] : 17

**WARNING:** the CE700 program considered that, both the 1st sensor in 1st CE380UR Remote Unit, and the 1<sup>st</sup> output relays, are the number 17. Why the first 16 sensors (and the first 16 relay outputs) corresponds to the inputs and outputs of internal CE700.SP ... Special Version, which may be required, but only when ordering.

**Suggestion:** To calculate the number of the 1st input and the 1st output into CE380UR, corresponding to the one programmed and displayed on the CE700, (see figure on page 6) use the formula:

$$9 + (8 \times \text{the number of the CE380UR}).$$

**Example:** 1st input and 1st relay of the 3rd CE380UR is  $9 \times (8 \times 3) = 33$

Use **↑PAGE** and **↓PAGE** keys to scroll the list of preconfigured and configurable sensors. (See Table 1 at page 25). ----->

Select desired sensor  
TS220EA

Press **ENTER** key to enter the selected sensor and to confirm; the display shows: ----->

Name: TS292KM

**NOTE:** Should you want to configure an input with a sensor, not present in the preconfigured sensor list, you should choose one sensor (preferably similar to the sensor to configure) and make the modification at the name as per indicated in Section "[keyboard use, general information](#)" on page 13.

Confirm pressing **ENTER** key and it appears the default *unit* of measurement that is the selected sensors.

Name: TS292KM  
Unit: %LIE

Press **ENTER** key to confirm, then it appears :----->

Alarm type: Increasing

With **↑PAGE** and **↓PAGE** key the alarm type can be turned into *Increasing*, *Decreasing*, *Oxygen* or *TLV*, by default the selected sensor appears.

**Increasing** is the choice most common, it means that the the alarms intervene to the growth of the signal of the sensor, (i.e. for the inflammable or toxic gases that in clean air indicate ZERO)

**Decreasing** is only an choice usable if the signal of the sensor decreases from the normal condition, (i.e. if the whole three levels of alarm are to be activated for lack of Oxygen).

**Oxygen** is a choice normally used for the sensors of Oxygen, to activate an Alarm for Excess of oxygen, a Pre-alarm and an Alarm for Defect of oxygen. Difetto d'Ossigeno.

**TLV** is a choice used only for the sensors of Toxic gas, to activate the in Alarms according to the limit values of exposure to polluting substances which the workers can be exposed to. Level 1 TLV-TWA, Level 1 **TLV-TWA**, Level 2 **TLV-STEL** and Level 3 **TLV-C**. (See on page 5 and the [Table 2 on page 24](#)).

Press **ENTER** key to confirm, then appears: ----->

Alarm type: Decreasing  
Area: 1

Up to **8 areas** can be selected (See section **Areas Setup**). If no area are utilised, let the No. 1 appears to defaults.

Press **ENTER** key to confirm, it appears the scale Zero value, setting preconfigured, that can be modify by using the numerical keys (for all the sensors is 0). ----->

Zero value: 0 \_ \_ \_

Then press **ENTER** key to confirm, it appears the

preconfigured sensor Range. If this doesn't correspond to the characteristics of the installed sensor, it can be modified using the numerical keys (**always check the characteristics of the sensor in the specific instructions**):----->

Zero value: 0 \_ \_ \_ \_  
Range: 20 \_ \_

Press **ENTER** key to confirm, then the following screens show the alarm level indication, as well as the corresponding outputs and weights:

Level 1: 7 \_ \_ \_

Level 1: 7 \_ \_ \_ Output: 0

Level 1: 7 \_ \_ \_ Output: 1\_

Weight: 10

Level 2: 15 \_ \_ \_ Output: 2\_

Weight: 10

Level 2: 20 \_ \_ \_ Output: 3\_

Weight: 10

As mentioned above, the proposed values (see [Table 1 on Page. 24](#)) can be either confirmed by pressing the **ENTER** key or modified, then confirming and finally going to next setting.

After the third alarm setting, the Central Unit Software will ask to configure the Fault output :

Fault output: 16

**NOTE:** Normally it is advisable to assign one relay output only to the Fault event, common for all the sensors.

Press **ENTER** key to confirm, the display will show the screen:

Confirm data ? : NO

Should you press the **YES** key and then **ENTER** key it will appear the message for few seconds:

Sensor stored

Then the software will go back to the Sensor Setup menu **Sensor Number**.

Should you press the **NO** key, instead, the program will ask you to confirm the cancelling operation:

Confirm sensor deletion ? : NO

Should you press **YES** key and then **ENTER** key, it appears: --

Sensor deleted

On the contrary the program will go back to the **Sensor Number** visualisation. Press **ESC** key to return to *Menu Sensors*.

**Note:** If more same sensors have to be configured it is possible to copy a sensor already configured (please see chapter **Copy sensor**). If instead, after having configured the first sensor, another one is decided to be configured, the program proposes a choice as the previous one.

Therefore the display will show the following message:

Ok for sensor: 'XXnnnXX' ?

Should the **NO** key be pressed, the message *Select*

*desidered sensor* will ask to make a choice among a list of preconfigured sensors; should the **YES** key be pressed the display shows the setup parameters, *Name: XXnnnXX\_* that can be confirmed or modified as described above

### SENSOR DELETION

from the *Menu Sensors*, press **2** **2-Delete** key, the message to insert the sensor number to delete will be displayed:

Sensor to delete [1-16] : \_ \_

Press **ENTER** key, it appears:

Confirm sensor deletion ? : NO

Press **ENTER** key to go back to the starting menu without executing any kind of modification. Otherwise,

press **YES** key and then **ENTER** key to confirm, it will appear the brief message:

Sensor deleted

The program will come back to the *Menu Sensors*.

### COPY SENSORS

from the *Menu Sensors*, press **3** **3-Copy** key, the message to insert the sensor number to delete will be displayed:

Sensor to copy [1-200]: \_ \_

Press **ENTER** key then will be requested from which up to the number you want to copy the selected sensor :

From [1-200] : \_ \_

To [1-200] : 18 \_

**Example:** If you need to configure 4 identical sensors connected to the inputs 17, 18, 19 and 20, after setting up the No 17 select it in "*Sensor to copy*" then select "*From: 18*" and then up "*To: 20*"

Press **ENTER** key to go back to the starting menu without executing any kind of modification. Otherwise, press **YES** key and then **ENTER** key to confirm, it will appear the brief message: ----->

Confirm data ? : NO

Copy effettuata

The program will come back to the *Menu Sensors*.

## SENSORS ENABLING AND DISABLING

It is possible to execute a virtual system exclusion of the sensor without having to disconnect it physically and deleting it from the program. In this case the Central Unit will still display the sensor mA read value, but this value will not have any effect neither on the alarms nor on the Central Unit outputs. Questa funzione è utile quando si devono eseguire verifiche o tarature oppure prima di scollegare un sensore da sostituire in caso di Guasto.

From the *main Menu*, press **1** key, to access to *menu Sensors*:

Respectively press **4** key (**4-Enable**) or **5** key (**5-Disable**), the display will require you ----->  
Digit the selected sensor number to *Enable* or to *Disable* and then press **ENTER** key to confirm.

Sensor to enable [1-16] : \_

Sensor to disable [1-16] : \_

Sensor not configured

Done

Should the sensor be not configured, it will appear an error message, otherwise it will appear the confirm message. After the Software will go back to the preceding menu.

Press **ESC** key to go back to the *Menu Sensors* and to the *Main Menu*.

## MODIFYING THE SENSORS SETUP

To modify an already configured sensor, two different ways are possible:

**A** - Should you wish to modify the type of sensor, it is better first to delete the sensor to be modified and then configure it again using new sensor settings.

**B** - Should you wish to modify either some alarm levels, or the output or weight selection, it is sufficient to follow the same procedure as for the sensor configuration (see section **Keyboard use and general information's**).

From the *menu Sensors* press the **1** key (**1-Configure**), then digit the sensor number to be modified, scroll with **ENTER** key the setting parameters until it appears the one to modify, then proceed with **ENTER** key until all the menus have been scrolled and press **YES** key at the request *Confirm data ?*. Press **ESC** key and the program will come back to *menu Sensors* and then to *main Menu*.

## BOARDS SET UP (Remote Units CE380UR)

From the *main Menu*, press **2** key (**2-Boards**), then from the *Boards Menu*, press **1** key (**1-Configure**), digit the CE380UR Remote Unit number to configure: ----->

Board number [1-22] : \_

Press **ENTER** key to confirm, then with **↑** **PAGE** and **↓** **PAGE** key select **NONE**, **COM1** or **COM2**.

Present ? : NONE

**NONE** appears if the CE380UR remote unit has not yet been configured.

**COM1** if the CE380UR remote unit is connected to the serial port RS232 converter.

**COM2** if the CE380UR remote unit is connected to the RS485 serial port.

Press **ENTER** key, then appears: ----->

Confirm data ? : NO

press **YES** key and then **ENTER** key to confirm, it will appear the brief message: ----->

Board stored

The program will come back to the *Boards Menu*.



## OUTPUTS SETUP

From the *Main menu*, press **2** key (**2-Outputs**), the display will ask you to digit the output (relay) number to configure: -->

Output number [1-16] : **1** \_

**IMPORTANT NOTE: the CE700 program considers that, the relay output number is in sequence, the outputs installed in the remote units CE380UR (ES380 boards). The 1st Output Relay on the 1st Remote Unit, is the No. 17. (Please see on page 14)**

Digit the output number, (using the numbers keypad) and press **ENTER** key, it will appear: ----->

Delay ON [0-250] : **1** \_

*"Delay ON"* is the relay activation delay (max 250 seconds) beginning from the exceeding of the corresponding alarm level.

Then, press **ENTER** it will appears: ----->

Delay ON [0-250] : **40**  
Delay OFF [0-250] : **1** \_

*"Delay OFF"* is the relay activation delay (max 250 seconds) beginning from the decreasing of the alarm level below the set threshold.

Then, press **ENTER** key, it will appear: ----->

Activation ON [0-250] : **0** \_

*"Activation ON"* indicates the time interval (max 250 seconds) during which the output keeps activating beginning from the exceeding of the corresponding alarm level. At the end of this time interval, the output (relay) returns to its initial conditions independently of either the input signal value is over the corresponding alarm level or is below it.

**ATTENTION:** *"Activation ON" setting is usable only when "Delay OFF" is setup to "ZERO" and the parameter Latched output is selected NO.*

Press **ENTER** key, it will appear:----->

Logic : Positive

*"Logic"* indicates the relay functioning, normally activated output (positive logic) or normally deactivated output (negative logic).

Select the desired logic using **↑ PAGE** or **↓ PAGE** key. Should have been inserting the 0 value when the displayed asked for the *Activation ON*, it will also appear the message:----->

Logic : Positive  
Latched output ? : NO

*"Latched output"* indicates if the output is to keep activating even if the value come back below the alarm level previously exceeded.

The selection is executed pressing **YES** and **NO** keys.

**ATTENTION:** *the "Latched output" can be set to YES only if the Delay OFF and the Delay ON are set to Zero. Normally this is set to YES not to allow the reset of the gas safety valve (both Manual Reset type and Automatic) without verification of the alarm status of the Central unit.*

Pressing **ENTER** key, it follows the request: ----->

Confirm data ? :NO

Press **YES** key and then **ENTER** key to confirm, it will appear the brief message----->

Output stored

The software will automatically go back to the output setup *Output Number* Press **ESC** to go back to the *Main menu*.

## OUTPUT DELETION

To delete an output it is necessary to select it, as described in the previous section (*OUTPUT SETUP*), and at the last request:----->

Confirm data ? :NO

keep **NO** and confirm with **ENTER** key. All the output settings for that output will be deleted. Press **ESC** key to return to the *Main menu*.

## AREAS SETUP

The *Areas* can be used in different ways, in compatibility with the number of the outputs available:

**A** - To group more sensors of the same model, setting only the Alarm levels, without set the relay output of the single sensors, but only in the *Area*, to use the same relay outputs for each sensors.

**B** - To group more different sensors (i.e.: placed in the same local), with the set of both alarm levels and different relay outputs for the single sensor and set in the *Area* the activation of relay outputs common to all of that sensors.

**C** - To use sensors with different *Weight* alarm. *For example, if 2 sensors have been both set with Alarm Level 2 choose with Weight 5 and assigned to Area number 3, the relay output will be activated only when both sensors exceed the alarm Level 2.*

**D** - To obtain that the output, set for that specific *Area* should activate, when at least one of the sensors belonging to that *area* exceeds the set alarm levels, or when the mean value of all the sensors grouped in that *area* exceeds the alarm level.

From the *Main menu*, press **3** key (**3-Zones**), the display will ask you to digit the *area* number to setup: ----->

Use the numerical keys for selecting the area to setup.

Press **ENTER** to confirm, it appears:----->

Digit, if request, the output number (relay) and press **ENTER**, key to confirm, it appears: ----->

then in sequence, will appear *Outputs* (5) for the other three Alarm Levels, digit, if request, the output number (relay) and press **ENTER** key to confirm, then it appears: ----->

Digit, if request, the output number (relay) to be associated to *Fault* and press **ENTER** key to confirm, it appears: ----->

*"mean value"* if you select **YES**, indicates that the outputs set for that specific *area* should activate when at least one of the sensors belonging to that *area* exceeds the set alarm levels, or when the mean value of all the sensors grouped in that *area* exceeds the alarm level.

Use **YES** or **NO** keys to select and **ENTER** key to confirm.

Then the display will ask you to confirm the executed settings: ----->

Press **YES** key to accept settings and confirm with **ENTER** key, it will appear the brief message : ----->

The software will automatically go back to the output setup

*Area Number* Press **ESC** to go back to the *Main menu*.

Area number [1-8] :

Level 1 output 1 : 0

Level 1 output 1 : 2  
Level 1 output 2 1 : 0

Fault output : 0

Consider the mean value ? :NO

Confirm data ? :NO

Area stored

## LANGUAGE

From the *Main menu*, press **4** key (**4-Language**), use **↑** and **↓** key to select a different language:

The *languages* are *Italian, French and English*.

Language : English

## CLOCK ADJUST (TIME AND DATA)

From the *Main menu*, press **5** key (**5-Varie**), then it appears the *Menu other*, press **1** key to *Clock* adjust:----->

Using **←** key to cancel and numeric keyboard, insert the adjourned *Data* with day (*DD*), month (*MM*) and year (*YY*), then press **ENTER** to confirm, it appears: ----->

Adjust the *Hour* with hour (*HH*) and minutes (*MM*), then press **ENTER** key to confirm and automatically go back to the *Menu other*.

Date [DDMMYY] 151009

Date [DDMMYY] 151009  
Hour [HHMM] 1645

## SUMMER TIME

The Central Unit software, automatically adjust the clock.

### HOW TO DISPLAY DATE AND HOUR

From the *normal sensors view* ([see to page 7](#)) press the  key to have Hour, Date and Mains Conditions (MAINS ON or MAINS OFF) : ----->  
 Press  key again to come back to the previous screen.

20-09-2009 11:57:05  
 MAINS ON

### MAINS BLACKOUT AND SERIAL LINE FALIURE

The Central Unit Software provides the opportunity to setup one output (relay) in case of a mains blackout. Of course batteries should be installed.  
 It is also possible to set up another output relay to signal any communication failure with the remote units CE380UR.

From the *main menu*, press  key (5-Other) then it appears the *menu other*, press then  key, it appears: ----->

Blackout output [0-16] : 0

Digit, if request, the output number (relay), and then press  key to confirm and automatically go back to the *menu other*. Press  key twice, to return to sensors' normal view.

### SERIAL PORT SET UP

From the *main menu*, press  key (6-Other) it appears the *menu other*, then press  key (3-COM1) it appears:----->

COM1 Function: PRINTER  
 COM2 Function: CE380UR

Or if press  key (4-COM2) it appears:----->

Use  and  key to select a different Serial Port options.

The options are: *PRINTER, MODBUS, CE380UR, PC/CE700UR* and *MODEM*.

**CE380UR** is the choice for connecting the remote units CE380UR.

**PRINTER** is the choice to be made only if you need to install the printer.

**MODEM** is the choice connecting the GPRS modem to send SMS messages on the status of the plant.

#### MODEM SET UP

From the *main menu*, press  key (6-Other) it appears the *menu other*, then press  key (3-COM1) or press  key (5-Modem) it appears:----->

Telephone : -----  
 Events : -----

**Telephone**: is inserted in the phone number to send the SMS.

**Events**: must be added-code number that is the type of event to be sent via SMS. ([See the next Table](#))

**TABLE CODES FOR SET UP THE MODEM**

CODE	FUNCTION	DESCRIPTION Leave message if:
1	Sensor alarm	a Detector exceeds the 3rd Alarm threshold
2	Normalization of a sensor	communicates that an Alarm condition is ended
3	Reset an alarm	Is been pressed the RESET key
4	Enabling a sensor	Warn if a Detector has been enabled
5	Disabling a sensor	Warn if a Detector has been disabled
6	Fault upward	a Detector has exceeded its full scale
7	Fault down	if a Detector is faulty or there is a lack of sensor signal
8	exceeded the first threshold alarm	a Detector has exceeded the 1st threshold allarm
9	exceeded the second threshold alarm	a Detector has exceeded the 2nd threshold allarm
A	Start Central unit	the CE700 Central Unit has been turned on
B	Mains blackout	the mains voltage is missing
C	Mains on	the Mains voltage has been returned
D	Overflow	a Detector is out of its full scale
F	Board Enabling	a remote unit CE380UR has been enabled
G	Board Disabling	a remote unit CE380UR has been disabled
H	Board Timeout	a remote unit CE380UR do not communicate

**EXAMPLE:** If you enter the sequence **1BC** this means you will receive an SMS when one or more sensors are above the third alarm threshold (**1**), or there is a lack (**B**) and the return of mains voltage (**C**). The letters are selected with YES and NO keys while the numbers with the numeric keys.

**MODBUS** is the choice to connect to a external system with protocol Modbus Rtu binary input. (The interface specifications will be provided on request). If you choose this option will be asked to enter the number of address: ----- >

MODBUS Address [1-64]: 1

#### Description of the Modbus communication

Communication via Modbus RTU binary, is done through the RS232 or RS485, with the following parameters: 19200 baud, no parity, 8 data bits, 1 stop bit.

The reading of the state of the sensors is done through the command Read Holding Registers (code 03). For each sensor are 2 registers (not consecutive). 1 to 200 are registers with the current values (same number of sensors), while 301 to 500 are the sensor status registers (register 301 contains the status of the sensor 1). Since the submitted values, are the word (16-bit signed), to represent decimal numbers, certain values are multiplied by a factor determined by the number of decimal places specified in the configuration of the sensor. If the decimal digits are 0, the value does not undergo multiplication. With a number, multiply it by 10, with 2 digits for 100 and 3 figures for 1000.

As for the status of the sensors, the table below explains the meaning of the possible values.

Value	Description
0	Sensor fault for lack of signal
1	Sensor underflow ( $\geq 2\text{mA} < 4\text{mA}$ )
2	Sensor in the normal state
3	Sensor in a state of pre-alarm AL1
4	Sensor in a state of pre-alarm AL2
5	Sensor in alarm AL3
6	Sensor overflow ( $> 20\text{mA} \leq 22\text{mA}$ )
7	Sensor fault for excessive signal

**NOTE:** The ModBus address of the control unit must be configured from the menu and can be selected between 1 and 100.

**PC/CE700UR** is the choice to be made if you want to connect to a PC with the SW700 management software or to the model CE700UR remote display unit. If you choose this option will be prompted to select the address. ----- >

Communication address [1-64]: 1

## PASSWORD SETTING

The **"Password"** is an access code that, if inserted, is used to protect all the Central System settings from any tampering through the action of inexperienced people. Should you wish to modify any setting about **inputs, outputs, areas**, the same **password**, etc, it will be necessary to digit the key work in the correct way.

From the *Main menu*, press **5** key (**5-Other**), then in the

*Menu Other*, press **3** key (**3-Password**), it appears: ----- >

Enter password : \_\_\_\_\_

That permits to insert, **using keys from 0 to 9**, a number with max eight numerical characters.

Press **ENTER** key to visualise the confirmation request: ----- >

Enter password: \*\*\*\*\*

Digit the **password** again and confirm with **ENTER** key, should

Enter password again : \_\_\_\_\_

the two passwords be equal, the display will show the message:----- >

New password stored

Should the two passwords are not equal; the display will show the message **ERROR Passwords are different**. Please repeat the Password setting.

Press **ESC** key more times to come back to normal view. From this moment onwards, any operation concerning modification of all sorts will be protected by the new entered password.

**To delete a password** it is necessary to proceed exactly in the same way as well as its setting, but for leaving the line blank (only spaces).

**ATTENTION: It's recommended to write and to preserve the Password in a safe place. In case of loss of the Password please contact our service assistance.**

## PRINTING (This key not be used in this version)

## EVENTS VISUALISATION

Starting from the *normal sensors view*, press **PRINT** key, it will appear the menu: ----->

**[016]: 1.Start printing 2.Stpo printing  
3.Reprint 4.Archive 5.Clear**

*The number put within square brackets indicates the number of the stored events (up to 999).*

Press **4** key, (**4-Archive**) to ask for the occurred-event initial date in *day (DD), month (MM), year (YY)* format:----->

**Starting date [DDMMYY] : █ -----**

*Should you digit one date on the display, it will appear the first stored event during that insert day, use*

**↓PAGE** and **↑PAGE** keys to scroll the events respectively ahead in the time or back in the time.

*Should you digit any date, press **ESC** key, it will appear the last stored event; press **↑PAGE** key to scroll the events back in the time.*

Should the selected date not contain events, it will appear the message:----->

**No events at the selected date**

And, after few seconds, the immediately previous event will be visualised.

*Should the selected day be former to every stored event, it will be visualised the first stored event. The first line of the event format includes the *hour* indication, as well as the *date* and the event *condition*. The second line indicates the *input number*, the *sensor name* as well as the *input value* if it is in faults, alarm conditions or overflow (*FAULT, AL1, AL2, AL3, OVERFLOW*). In the events, also the Central Unit *starting*, the *mains blackout*, the *main return*, as well as the *reset* are indicated.*

## EVENTS DELETION

Starting from the *normal sensors view*, press **PRINT** key, it will appear the menu: ----->

**[016]: 1.Start printing 2.Stpo printing  
3.Reprint 4.Archive 5.Clear**

*The number put within square brackets indicates the number of the stored events (up to 999).*

Press **5** key, the display will ask you to confirm the event deletion operation:----->

**Do you want clear events file ? :NO**

Press **NO** key and confirm with **ENTER** key, to go back to the *Printing menu*.

**Press **YES** key and confirm with **ENTER** key to cancel all the events present in memory.**

After the above message, it will return back to the *Printing menu* automatically.

**Events file cleared**

Press **ESC** key, to go back to the *normal sensors view*.

## CENTRAL UNIT HARDWARE TEST

Using the Central Unit *TEST* program it will be possible to verify the keyboard and of all the relays and inputs functioning.

**ATTENTION:** *this procedure has to be carried out with high care by authorized and trained personnel, since both the output relays controlling the connected devices and the internal functions are activated.*

To accede to *Test* procedure, it is necessary to disconnect the battery, if installed, then switch off the mains, then switch on again the Central System and when the following message appears:

**CE700 – 3.x - by TECNOCONTROL**

Within two seconds, press  key, it will appear the following message, sorry if in Italian language:

**TEST: 1.Tastiera (Keyboard) 2. Ingressi (Inputs) 3. Uscite (Outputs)  
4. RS232 (serial Port COM1) 5. RS485 (serial Port COM2)**

Press  key "*1-Tastiera = Keyboard*", it appears the message "*Premere i tasti = Press Keys*". Press each key to visualise the corresponding key functions.

<input type="button" value="PAGE"/>	FRECCIA GIU=DOWN	<input type="button" value="PAGE"/>	FRECCIA SU=UP	<input type="button" value="RESET"/>	RESET	<input type="button" value="PRINT"/>	PRINT	<input type="button" value="0"/>	0 up to >	<input type="button" value="9"/>	9
<input type="button" value="."/>	. (Point)	<input type="button" value="←"/>	CANCELLA=DELETE	<input type="button" value="ENTER"/>	ENTER	<input type="button" value="NO"/>	NO	<input type="button" value="YES"/>	SI=YES	<input type="button" value="ESC"/>	ESC

After completing the test, press  twice, it will appears the Menu "*TEST*"

**NOTE:** the test "*2-Ingressi = inputs*" is not available in this version.

**NOTE:** the test "*3-Uscite = outputs*" is not available in this version.

**NOTE:** the *4-RS232 Test* is a factory reserved function. To test both *RS232 serial port* and *Printer* (only if installed), is enough using the PRINT key.

Press  key "*5-RS485*", only if the remote units CE380UR are present it can control inputs.

*If the CE380UR called is not installed, or is disconnected, or not powered, it apperars an error message (ERRORE = Error).----->*

**Errore -15**

Press  key, digit the number of CE380UR to be tested (*Numero scheda = Board number*) Confirm with  key, it appears the mA value of the selected CE380UR . ----->

**RS485 test**

Numero scheda [1-23] :

1= 0.0	2= 0.0	3= 0.0	4= 0.0
5= 0.0	6= 0.0	7= 0.0	8= 0.0

**Note** that the display shows all eight mA inputs available on the selected CE380UR, the unrelated sensors or failures are displayed with a ZERO value.

Then press  key to display the output from **Relay 1 up to 8.**----->

1= OFF	2= OFF	3= OFF	4= OFF
5= OFF	6= OFF	7= OFF	8= OFF

Press  key to activate **Relay No 1**, press  again to deactivate. Then in the same way, press  key to activate and deactivate **Relay No 2** and so on until press  key to activate and deactivate **Relay No 8**.

**Note** that the Output Relays (ES380UR card) should be present in the selected CE380UR.

To calculate the corresponding CE700 displayed input and output number of the 1st 4÷20mA input or the 1st output relay , in the CE380UR ([see also figures on page 6](#)) use the formula:  $9+(8 \times \text{CE380UR Number})$ .

**Example:** The 1<sup>st</sup> input and the 1<sup>st</sup> relay in the 3th CE380 is:  $9+(8 \times \text{No } 3) = 33$

Press  key it will return to *Numero Scheda = Board number*

Press  key twice, to go back to the *Normal functioning*. It will appears the starting message.

**Wait . . . 90**

## APPENDIX

CE700 TECHNICAL SPECIFICATIONS		
Power Supply	230 Vac (-15/+10%) - 50 Hz (±10%)	
Minimum power at 230V	10VA	
Serial Ports	No 1 RS485 and No 1 RS232	
Maximum power from power supply	2,5 A at 24Vcc	
Working temperature with battery	+5 ÷ +40 °C	
Pb Buffer battery (on request) <sup>(NOTE 1)</sup>	No 1 12 Vdc - 7 Ah	
Battery Life	About 6 hours' full charge	
Display	40 characters on two lines back lighted LCD	
Keyboard	20 membrane keys	
Dimensions	CE700P 365x305x105 mm	CE700R Rack 19" 3U
Weight	CE700P 2.5 Kg	CE700R 3Kg

**(NOTE 1)** Inside the enclosure of CE700 can be installed No.1 12V-7Ah batteries Pb.  
CE700R model can accept No 1 12V-7Ah battery to be positioned in 19" cabinet.

### WARNINGS AND FAULT MESSAGES LIST

<u>No configure sensors</u>	No sensors has been configured
<u>FAULT-</u>	The input signal is less then 1 mA. The sensor could be damaged, no connected or not powered.
<u>AL1</u>	The alarm 1 level has been exceeded and the configured output is activated.
<u>AL2</u>	The alarm 2 level has been exceeded and the configured output is activated.
<u>AL3</u>	The alarm 3 level has been exceeded and the configured output is activated.
<u>OVERFLOW+</u>	The input signal is between 21 and 24 mA. The sensor is detecting gas but it exceeds its full-scale
<u>FAULT+</u>	The input signal is more then 24 mA. The sensor could be damaged, or is detecting gas but it exceeds its full-scale.
<u>Wrong password</u>	A wrong access Code has been inserted.
<u>Sensors data lost</u>	configuration data Sensors have been lost.
<u>Outputs data lost</u>	configuration data Outputs have been lost.
<u>Areas data lost</u>	configuration data Areas have been lost.
<u>Event data lost</u>	configuration data Events have been lost.
<u>Configuration Lost !</u>	all the configuration data have been lost. ( <a href="#">see NOTE on page 2</a> )

**TABLE 1 - 4÷20 mA PRECONFIGURED GAS DETECTORS LIST**

TOXIC GAS DETECTORS				Recommended alarm levels		
MODEL	Detected Gas	RANGE	UNIT	AL1 Level 1	AL2 Level 2	AL3 Level 3
<b>TS220EA</b> (TS220EA-H, TS293EA, TS293EA-H)	NH <sub>3</sub>	0-300	ppm	10 <sup>(2)</sup>	20	50
<b>TS220EC</b> (TS220EC-S, TS220EC-H, TS293EC-S, TS293EC-H)	CO	0-300	ppm	25 <sup>(2)</sup> ÷50	100	200
<b>TS220EH</b> (TS293EH)	H <sub>2</sub> S	0-100	ppm	10	20	<b>50</b>
<b>TS220EN</b> (TS293EN)	NO	0-100	ppm	10	20	50
<b>TS220ES</b> (TS293ES)	SO <sub>2</sub>	0-20.0	ppm	5.0	7.5	10.0
<b>TS220EX</b> TS220EHCN - TS293EHCN	HCN	0-10.0	ppm	2.0	3.0	5.0
TS220ECL - TS293ECL	CL <sub>2</sub>	0-10.0	ppm	0.3	0.5	1.0
TS220EHCL - TS293EHCL	HCL	0-10.0	ppm	3.0	5.0	10.0
TS220EN2 - TS293EN2	NO <sub>2</sub>	0-30.0	ppm	3.0	6.0	15.0

FLAMMABLE GAS DETECTORS				Recommended alarm levels		
MODEL	Detected Gas	RANGE	UNIT	AL1 Level 1	AL2 Level 2	AL3 Level 3
<b>TS292KG</b>	LPG (Butane)	0-20	%LEL	6 <sup>(2)</sup>	15	20
<b>TS292KM</b> (TS292KB, TS292KI)	METHANE	0-20	%LEL	7 <sup>(2)</sup>	15	20
<b>TS292KB</b> (TS293KB)	GASOLINE Vap.	0-20	%LEL	6 <sup>(2)</sup>	15	20
<b>TS292KI</b> (TS293KI)	HYDROGEN	0-20	%LEL	6 <sup>(2)</sup>	15	20
<b>TS293KG</b>	LPG (Butane)	0-20	%LEL	7 <sup>(2)</sup>	15	20
<b>TS293KM</b>	METHANE	0-20	%LEL	6 <sup>(2)</sup>	15	20
<b>TS292Px<sup>(1)</sup></b> (TS292PM, TS292PG, TS292PI, TS292PB)	FLAMMABLE	0-100	%LEL	7 <sup>(2)</sup>	10÷15	20÷30
<b>TS293Px<sup>(1)</sup></b> (TS293PX, TS293PX-H, TS293PE, TS293PS)	FLAMMABLE	0-100	%LEL	6 <sup>(2)</sup>	10÷15	20÷30

INFRARED(NDIR) FLAMMABLE GAS DETECTORS				Recommended alarm levels		
MODEL	Detected Gas	RANGE	UNIT	AL1 Level 1	AL2 Level 2	AL3 Level 3
TS293IE	ACETYLENE	0-100	%LEL	8 <sup>(2)</sup>	12	20
TS293IG	LPG (Butane)					
TS293IM	METHANE					
TS293IX	FLAMMABLE					

INFRARED(NDIR) ASPHYXIATING GAS DETECTORS				Recommended alarm levels		
MODEL	Detected Gas	RANGE	UNIT	AL1 Level 1	AL2 Level 2	AL3 Level 3
TS220IC2 - TS293IC2	CO <sub>2</sub>	0-5.00	%volume	0.50	1.00	2.00
TS220IC2-H - TS293IC2-H	CO <sub>2</sub>	0-5000	ppm	1000	1800	2500
TS210IC2 - IR101 / IR102	CO <sub>2</sub>	0-2.00	%volume	0.20	0.50	1

PARKING GAS DETECTORS, WITH TWO SENSORS				Recommended alarm levels		
MODEL	Detected Gas	RANGE	UNIT	AL1 Level 1	AL2 Level 2	AL3 Level 3
<b>TS255CB</b> (TS250CB)						
Configure the CO as TS220EC	CO	0-300	ppm	30	60	150
Configure the GASOLINE Vapor as TS292KB	GASOLINE Vap.	0-20	%LEL	7 <sup>(2)</sup>	10	20

PARKING GAS DETECTORS, WITH TWO SENSORS				Recommended alarm levels		
MODEL	Detected Gas	RANGE	UNIT	AL1 Level 1	AL2 Level 2	AL3 Level 3
<b>TS255CN2</b>						
Configure the CO as TS220EC	CO	0-300	ppm	30	60	150
Configure the NO <sub>2</sub> as TS220EN2	NO <sub>2</sub>	0-30.0	ppm	3.0	6.0	15.0

OXYGEN GAS DETECTOR				Recommended alarm levels		
MODEL	Detected Gas	RANGE	UNIT	AL1 Level 1	AL2 Level 2	AL3 Level 3
<b>TS220EO</b> (TS293EO)	OXYGEN	0-25.0	%volume	22.5 <sup>(4)</sup>	19.5 <sup>(3)</sup>	18.5 <sup>(3)</sup>

(1) All TS293P series, are calibrated with 100%LEL range, it will change only the calibration gas.

(2) It is not recommended to set pre-alarm levels lower than the value indicated.

(TS.....) Models in bold are those preconfigured in Central. Those in brackets have characteristics identical to the first in bold, but differ in the type of protection of the enclosure. Others not in bold are configurable, but not present in the pre-configured list.

(3) Alarm for oxygen deficiency ([see on page 14](#)).

(4) Alarm for oxygen excess. ([see on page 14](#)).



**TABLE 2 - RECOMMENDED TLV VALUES (for Toxic Gases)**

MODEL	Detected Gas	RANGE	UNIT	Alarm levels		
				TLV-TWA <sup>2)</sup> AL1 Level 1	TLV-STEL AL2 Level 2	TLV-C AL3 Level 3
<b>TS220 EA</b> (TS220 EA-H, TS293EA, TS293 EA-H)	NH <sub>3</sub>	0-300	ppm	25(COSHH) / (OSHA)	35(COSHH)	50(OSHA)
<b>TS220 EC</b> (TS220EC-S, TS220 EC-H, TS293 EC-S, TS293 EC-H)	CO	0-300	ppm	30 (COSHH)	200 (COSHH)	250
<b>TS220 EH</b> (TS293EH)	H <sub>2</sub> S	0-100	ppm	5 (COSHH)	10 (COSHH)	20
<b>TS220EN</b> (TS293EN)	NO	0-100	ppm	25 (COSHH) / (OSHA)	25 (COSHH)	50 (OSHA)
<b>TS220ES</b> (TS293ES)	SO <sub>2</sub>	0-20.0	ppm	2 (COSHH)	5 (COSHH)	10
<b>TS220EX</b>						
TS220 ECL - TS293ECL	CL <sub>2</sub>	0-10.0	ppm	0.5(OSHA)	0.5(COSHH)	1.0
TS220EHCL - TS293EHCl	HCL	0-10.0	ppm	5.0 (OSHA)	5.0 (COSHH)	10.0
TS220EHCN - TS293EHCN	HCN	0-10.0	ppm	4.7 (OSHA)	10 (COSHH)	4.7 (OSHA)
TS220EN <sub>2</sub> - TS293EN <sub>2</sub>	NO <sub>2</sub>	0-30	ppm	3.0 (COSHH)	5.0 (COSHH)	15.0
TS220IC <sub>2</sub> - TS293IC <sub>2</sub>	CO <sub>2</sub>	0-5.00	%volume	0.50(COSHH) / (OSHA)	1.50(COSHH)	3.00
TS210IC <sub>2</sub> - <b>IR101 / IR102</b>	CO <sub>2</sub>	0-2.00	%volume	0.50(COSHH) / (OSHA)	1.50(COSHH)	2.00

**COSHH** = European Department - **OSHA** = U.S. Department - ([see on page 5](#))

**SETUP MEMORANDUM TABLE**

*It is recommended to compile these tables, as a reminder of the configuration done. Furthermore these data should be photocopied and attached a copy to the central and other documentation of the plant.*

**CE380UR No [1÷23] :**  **Serial Port:**  COM1(RS232)  COM2(RS485)

<b>Sensors Setup</b>	<b>Sensore Number [17÷200]</b>								
	<b>Sensor Name</b>								
	<b>Annotations</b>								
<b>Unit of measurement</b> (ppm, %LIE o %)									
<b>Alarm type</b> (Increasing ↑ or Decreasing ↓ or Oxygen or TLV)									
<b>Area</b> (1÷8)									
<b>Zero value</b> (Normal = 0)									
<b>Range</b> (Max 99.9 or 9999)									
<b>Level 1</b> (AL 1 or AL 3 if setting Oxygen alarm type)									
<b>Output 1</b> (Relay Number)									
<b>Weight 1</b> (Normal = 10)									
<b>Level 2</b> (AL 2 or AL 1 if setting Oxygen alarm type)									
<b>Output 2</b> (Relay Number)									
<b>Weight 2</b> (Normal = 10)									
<b>Level 3</b> (AL3)									
<b>Output 3</b> (Relay Number)									
<b>Weight 3</b> (Normal = 10)									
<b>Fault</b> (Relay Number)									

<b>Outputs Setup <sup>(1)</sup></b>	<b>Output Number [17÷200]</b>								
	<b>Annotations</b>								
<b>Delay ON <sup>(1)</sup></b> (from 0 to 250 Seconds)									
<b>Delay OFF <sup>(2)</sup></b> (from 0 to 250 Seconds)									
<b>Activation ON <sup>(3)</sup></b> (from 0 to 250 Seconds)									
<b>Logic</b> (Negative or Positive)									
<b>Latched output <sup>(4)</sup></b> (NO or YES)									

**NOTE <sup>(1)</sup>** - You should always set a value is between 10 and 60 seconds. (Typically 10 to 20" for optical / acoustic Pre-alarms and 30 ÷ 60" Gas electro valve).

**NOTE <sup>(2)</sup>** - Normally leave ZERO. It is used only to enable appliance should not continue to operate beyond the alarm.

**NOTE <sup>(3)</sup>** - Normally leave ZERO. The "Activation ON" is set only if "Delay OFF" is "ZERO" and selected NO the "Latched output".

**NOTE <sup>(4)</sup>** - the "Latched output" should be set to "YES", only if "Delay OFF" and "Activation ON " are set to "ZERO". Normally this parameter should be set to "YES" to prevent the rearmament of an actuator (e.g. the manual resetting gas valve) without first verifying that the Central Unit is in alarm.

**Area setup**

	<b>Central Unit CE700</b>																								
<b>Area Number [1÷25]</b>	1	2	3	4	5	6	7	8	9	10	11	12	13	14	15	16	17	18	19	20	21	22	23	24	25
Level 1 output 1 (Relay Number)																									
Level 1 output 2 (Relay Number)																									
Level 1 output 3 (Relay Number)																									
Level 1 output 4 (Relay Number)																									
Level 1 output 5 (Relay Number)																									
Level 2 output 1 (Relay Number)																									
Level 2 output 2 (Relay Number)																									
Level 2 output 3 (Relay Number)																									
Level 2 output 4 (Relay Number)																									
Level 2 output 5 (Relay Number)																									
Level 3 output 1 (Relay Number)																									
Level 3 output 2 (Relay Number)																									
Level 3 output 3 (Relay Number)																									
Level 3 output 4 (Relay Number)																									
Level 3 output 5 (Relay Number)																									
Fault output (Relay Number)																									

**ANNOTATIONS:**

.....  
 .....  
 .....  
 ✂ .....

<b>Password</b>	<b>Central Unit Model</b>	<b>Central Unit Serial Number</b>
	<b>CE700</b>	SN:
<b>CE380UR Total Number Installed</b>		

**ATTENTION:** It is advisable to write and store the Password in a secure place. In case of loss of the Password, contact our Assistance Department